

VOLVO

P 750

FM 460 HP 8X4 BL

NUMERO DI CONTRATTO: 11750050

NUOVO

IN PRODUZIONE



INFORMAZIONI OFFERTA

Dettagli sulla posizione

Löbau, 02708 - Germania 

Dettagli dealer

Palfinger Platforms GmbH

Tipologia di prodotto

Nuovo

Numero di contratto

11750050

Email del venditore

sales.platforms@palfinger.com

Telefono del venditore

004935854796121

Produttore	PALFINGER	Rotazione torre	540°
Modello	P 750	Dimensioni cesto	3,88 x 1,05 x 1,10 m
Anno di costruzione	2024	Capacità di carico	max. 600 kg
Sbraccio	max. 39,00 m	Rotazione cesto	+/- 200°
Altezza Max. di Lavoro	75,00 m	Materiale cesto	ALU
Produttore	Volvo	Potenza	469 PS/345 kW
Tipologia di veicolo	FM 460	Emissioni	EURO 6
Cabina	FM-DAY	Assi	8x4
Passo	5600 mm	PTT	32.000 kg
		Construction	Piattaforma di lavoro aerea

P 750

SENSATIONAL WORKING HEIGHT

LIFETIME EXCELLENCE

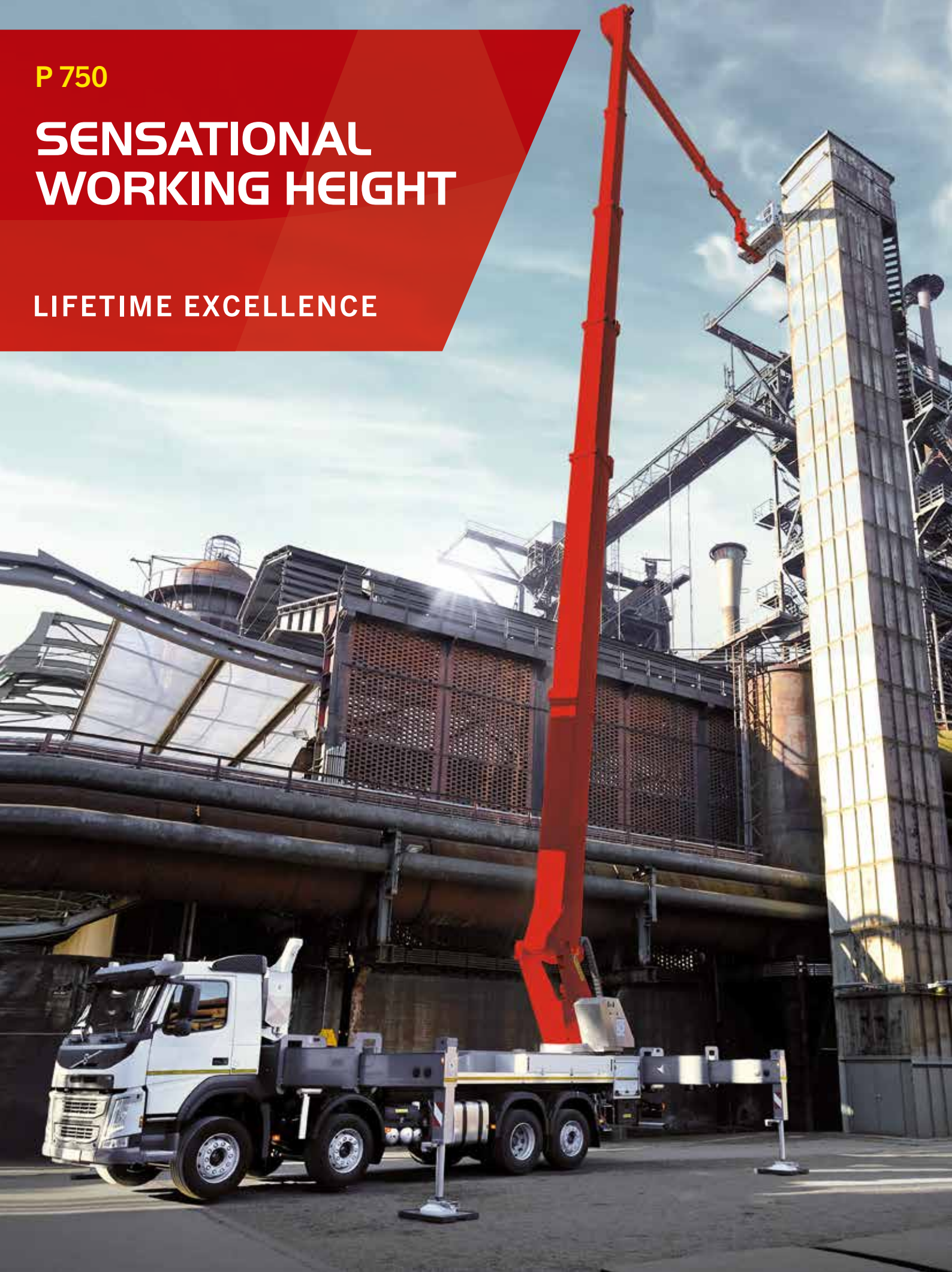

HIGHLIGHTS

- Greater working range thanks to 240° X-jib
- 2 x 200° basket rotation for perfect positioning of the workman basket
- Telescopic upper boom up to 19 m total length
- Automatic telescope lubrication system supplies the lower boom telescopes with grease during platform operation
- Telescopic basket with up to 600 kg basket load and integrated preparation for Powerlift-System
- Hanging basket enables operators to work close to objects

STANDARDS













- Rear view camera
- Memory-Function
- Automated positioning system
- Telescopic basket
- Driver information system
- Safety spreader plates
- 230 V CEE current supply with CEE socket in the workman cage
- Assistance systems

OPTIONS

- Powerlift-System: Transport device for working material with max. 600 kg payload to be carried externally on the basket.
- Material handler/crane in basket for lifting objects from the Powerlift and direct assembly at the place of use (400 kg payload).
- Telescopic camera basket with 600 kg basket load including mount for film illumination
- Ultrasonic sensors to protect the workman basket from collisions
- Mobile radio remote controls for access platform and stabilizer operation
- Access from both sides (access ladder on right and left-hand side) with lighting



TECHNICAL SPECIFICATIONS

	Total weight *	32200 kg		max. outreach	39 m
	Overall length	14.10 m		Rotation angle of turntable	540°
	Width in transportposition	2.54 m		Rotation angle of cage	2 x 200°
	Height in transportposition	3.95 m		Rotation angle of cage boom	240°
	max. stabiliser width	8.89 m		Size of cage	3.88 x 1.05 x 1.10 m
	max. working height	75 m		max. cage load	600 kg
	max. cage bottom height	73 m			

* Depends on truck chassis

WORKING DIAGRAMS

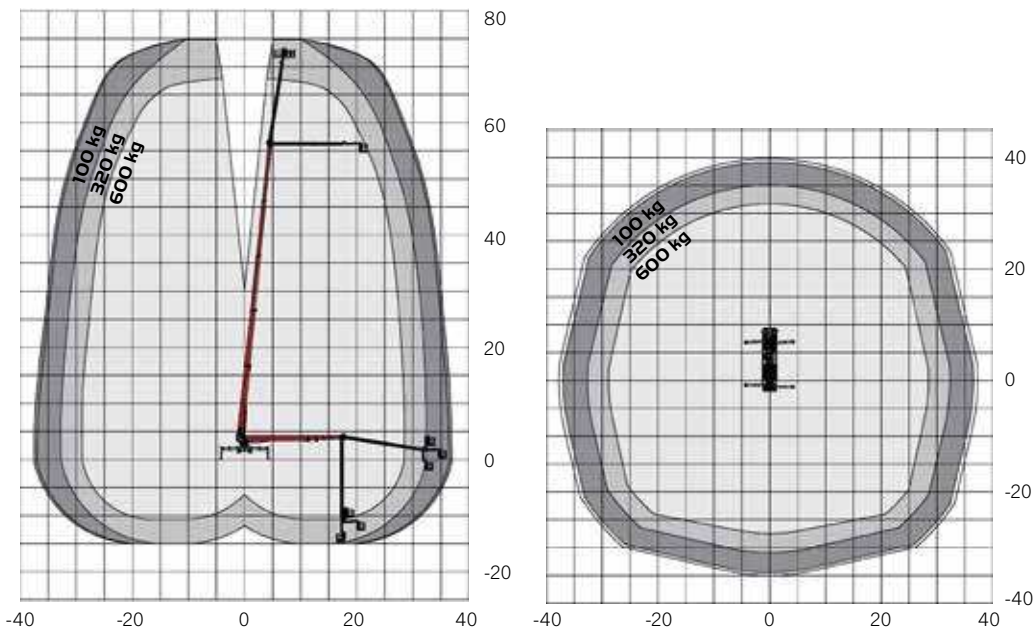

* A possible 2% tolerance is contingent on structural components

DIMENSIONS

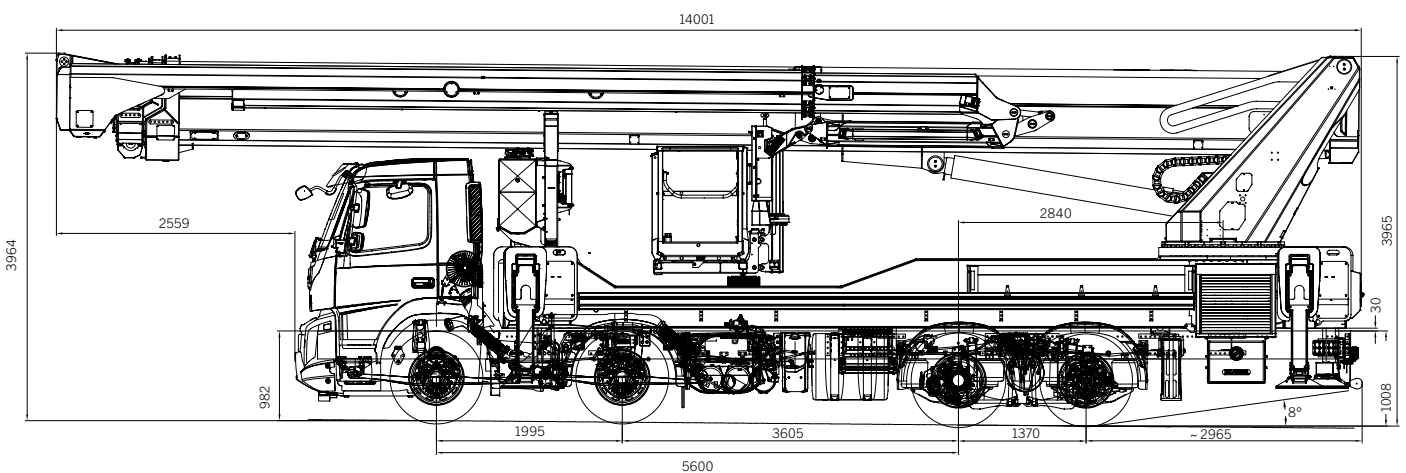

YOUR CONTACT

Palfinger Platforms GmbH

Düsseldorfer Str. 100
47809 Krefeld | Germany

KP-P750M2+EN

Units shown in the leaflet are partially optional equipped and do not always correspond to the standard version. Country-specific regulations must be observed. Dimensions may vary. Subject to technical changes, errors and translation mistakes.