

MERCEDES

P 220 BK

BENZ SPRINTER 315 CDI 4X2

NUMERO DI CONTRATTO: P220BK STANDARD

NUOVO

ON STOCK

DISPONIBILE



INFORMAZIONI OFFERTA

Dettagli sulla posizione

Löbau, 02708 - Germania 

Dettagli dealer

Palfinger Platforms GmbH

Tipologia di prodotto

Nuovo

Numero di contratto

P220BK Standard

Email del venditore

sales.platforms@palfinger.com

Telefono del venditore

004935854796121

Produttore	PALFINGER	Dimensioni cesto	1,40 x 0,70 x 1,10 m
Modello	P 220 BK	Capacità di carico	300 kg
Anno di costruzione	NEU - NEW	Rotazione cesto	+/- 90°
Sbraccio	16,9 m	Basket arm angle	185°
Altezza Max. di Lavoro	22,0 m	Materiale cesto	Aluminium
Rotazione torre	500°		
Produttore	Mercedes Benz	Potenza	110 kW (150 PS)
Tipologia di veicolo	Sprinter 315 CDI	Emissioni	EURO 6
Anno di costruzione	NEU - NEW	Assi	4x2
Passo	3.665 mm	PTT	3.500 kg

PALFINGER

P 220 BK

AGILE AND COMPACT

LIFETIME EXCELLENCE

PALFINGER P 220 BK

HIGHLIGHTS

- Stabiliser operation from the base for easy and safe support
- Robust aluminium workman basket with 3000 kg cage load and integrated anti-squeeze protection function in the knee rail
- Automatic support stabilising with wheel clearance monitoring
- Flat substructure under the workman basket allows users to get as close to obstacles as possible
- Full range with vertical support on large chassis (7.5t)

STANDARDS













- Home function
- Automated positioning system
- Safety plates
- 230V CEE current supply with CEE socket in the workman basket
- European type approval
- Stabiliser control at basis

OPTIONS

- Tree maintenance package (tree basket, wooden edge, protective roof, chainsaw mount)
- Protective grating above cab
- Display at the base, including height limitation
- Display in the workman basket, including adjustment of ramps
- Aluminium edging
- Dual insulation with plastic basket



TECHNICAL SPECIFICATIONS

	Total weight *	3330 kg		max. outreach	16.90 m
	Overall length	7.40 m		Rotation angle of turntable	500°
	Width in transport position	2.22 m		Rotation angle of cage	2 x 90°
	Height in transport position	2.99 m		Rotation angle of cage boom	185°
	max. stabiliser width	3.60 m		Size of cage	1.40 x 0.70 x 1.10 m
	max. working height	22 m		max. cage load	300 kg
	max. cage bottom height	20 m			

* Depends on truck chassis

WORKING DIAGRAMS

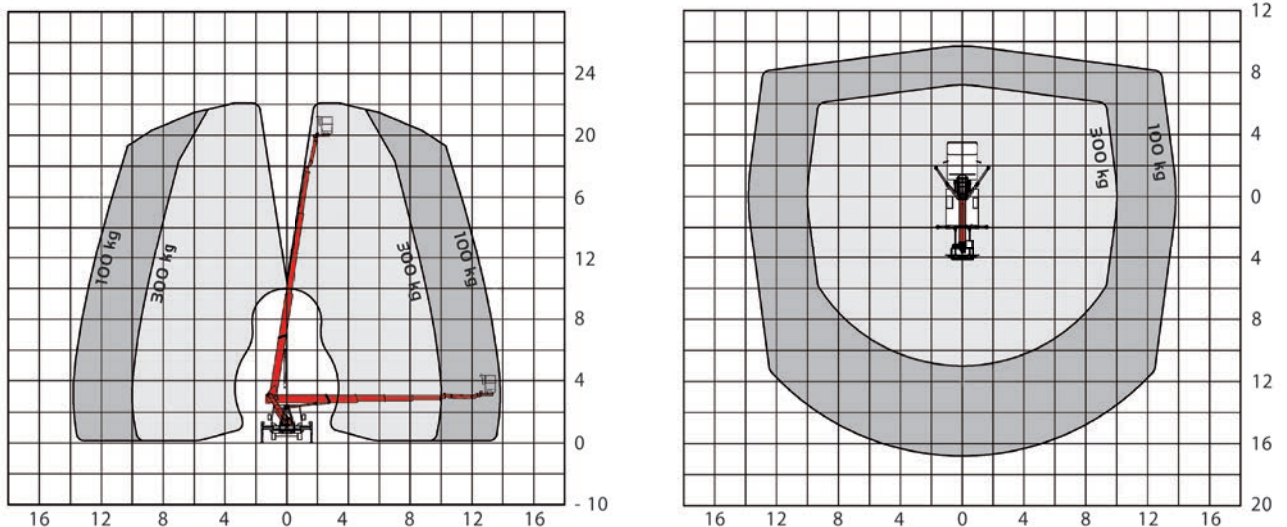

A possible 2% tolerance is contingent on structural component

DIMENSIONS

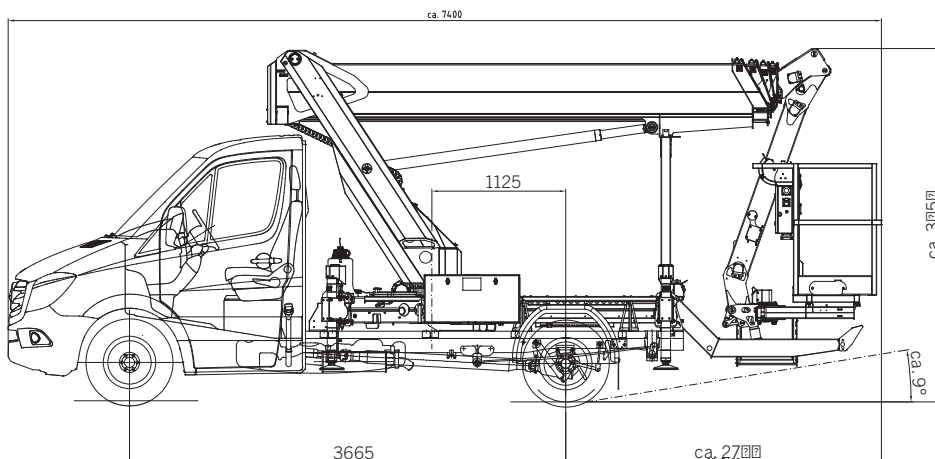

YOUR CONTACT

Palfinger Platforms GmbH
Düsseldorfer Str. 100
47809 Krefeld | Germany

KP-P220BKM1+EN

Units shown in the leaflet are partially optional equipped and do not always correspond to the standard version. Country-specific regulations must be observed. Dimensions may vary. Subject to technical changes, errors and translation mistakes.

Platforms | Area sales Manager



Head of sales
Michael Gruböck

Laura Garagnani
Responsible Areas:
France, Portugal, Spain

Dieter Schlosser
Responsible Areas:
Switzerland, Slovakia,
Hungary, Romania, Bulgaria,
Australia, New Zealand,
Georgia, Ireland,
United Kingdom

Timo Lenzen
Responsible Areas: Norway,
Sweden, Finland, Island,
Denmark, Faroe Islands,
Latvia, Lithuania, Estonia,
Czech Republic, Poland,
Ukraine, Moldova

Johann Poschner
Responsible Areas:
Germany, Austria

Adnan Isso
Responsible Areas:
Netherlands, Belgium,
Luxembourg

ALFREDO CAREDDU
Responsible Areas:
Italy, Malta

Mohammed AlNajmi
Responsible Areas: Slovenia,
Croatia, Greece, Cyprus,
Serbia, Bosnia, Kosovo,
Montenegro, Albania,
Macedonia, Israel, Turkey,
Georgia, Syria, Lebanon,
Jordan, Iraq, Iran,
Afghanistan, Saudi Arabia,
Kuwait, Bahrain, Qatar, UAE,
Oman, Yemen

Mohammed AlNajmi
Responsible Areas:
Africa

