

MAN

PK 580 TEC

TGS 35.520 8X4H-6 BL

CONTRACT NUMBER: PALDRIVE 393

NEW

ON REQUEST



SPECIFICATION

MAN + PK 580 TEC + PALFINGER Installation

All pictures taken from a reference project

Crane: PK 580 TEC

- Hydraulic 7-fold extension
- High-speed extension system with return oil recovery
- Swivel range endless
- Hydraulic support leg extension (max. support width 7.800 mm)
- Additional hydraulic support (support width ca. 5.200 mm)
- Support legs can be swiveled hydraulically through 180 °
- Paltronic 180

OFFER INFORMATION

Location details

MCC-NORTH SOLEC, 86-050 - Poland 

Dealer Name

Palfinger EMEA GmbH PL



Availability

On request

Product type

New

Contract number

Paldrive 393

Dealer E-mail

sales@palfinger.com

Dealer phone

004366488345792

- HPSC + LOAD
- PALCOM P7 radio remote control/ 9 functions with cross levers
- Painting RAL3020
- Working lights on the articulated arm and on the fly-Jib
- Hose equipment for two additional devices including quick coupling
(multi-faster)
- 3,5 t - cable winch on the main arm (hydr. foldable), cable length: 90 m
- Synchron control rope winch (SRC)
- 11,5 + 25 to load hook

Accessory: PJ150E (additional knuckle arm)

- Hydraulic 6-fold extension
- Can be folded upwards hydraulically by 25 °
- Applications with additional devices possible (e.g. gripper, rotator ...)
including quick coupling (multi-faster)

Platform:

- Inner dimensions: 2480 x 6300 mm
- Front wall: height 1900 mm
- Side- and rearwalls height: 400 mm
- Platform floor 27 mm plywood, impregnated and sealed

Chassis: MAN TGS 35.520 8x4H-6 BL

-
- 520 HP , max. 2.650 Nm
 - Automatic drive, MAN TipMatic 12.28 OD
 - Leaf suspension on front axles, air suspension on rear axles
 - Fuel tank 390l / AD-Blue tank 35l
 - Tyres rear axle 315/65R22,5
 - Tyres front axle 385/65R22.5
 - Cabin colour: RAL 9016 traffic white / chassis colour: RAL9011
graphite black

PRODUCT

Manufacturer	Palfinger	Lifting moment	55,5 mt
Model	PK 580 TEC	Outreach / Lifting power	31,4 m / 390 kg
Construction year	2023	Max outreach	31,4 m

TRUCK

Truck manufacturer	MAN	Axes	8x4
Construction year	2023	Gross vehicle weight	32.000 kg
Drivers cabine	TM	Dead weight	21.700 kg
Wheel base	1795 + 3505 + 1350 mm	Payload	10.300 kg
Power	520 PS	Payload category	6t - 15t
Emmission standard	EURO 6	Construction	Crane and platform

Konstruktionsänderungen vorbehalten, fertigungstechn. Toleranzen müssen berücksichtigt werden.

Krendarstellung symbolisch

DPS-C
Dual Power System



:Eigengewicht JV1
40 kg

Die Tragkräfte laut Diagramm verringern sich bei Verwendung von mechanischen Verlängerungen um deren Eigengewicht.
Die Tragkräfte laut Diagramm verringern sich bei Verwendung von Schlauchausrüstung am Fly-Jib.



Zulässige Traglasten für Seilwinde siehe Datenblatt
Seite 020.21000 2.5t Seite 020.21100 3.5t

PK 580 TEC

HEAVY-DUTY CRANE WITH PRECISION



PK 580 TEC THE PRECISION EXPERT

It is one of the precision experts in the heavy-duty crane segment. The TEC crane, like all its siblings, is in a league above the crane designation. With this crane we have optimally used previous knowledge and integrated the brand new **PALTRONIC 180** with the precise **LX-6 CONTROL VALVE**. This makes numerous new assistance systems possible, which again significantly increase the comfort of the PALFINGER TEC crane operator. The unmistakably elegant and functional design of the P-Profile crane also makes the PK 580 TEC something very special.



P-PROFILE

Lightweight construction in perfection

The polygonal or teardrop-shaped P-profile is the signature feature of the PALFINGER TEC-range. The torsion-resistant profile shape ensures a torsionally stable and at the same time lighter extension boom system. This results in a lower crane weight with higher performance. The extension booms also slide much better regarding the special shape and the self-lubricating plastic packages. This also means a particularly low-maintenance. The P-profile thus enables more efficient use in everyday work.



LEVELING ASSISTANT*

Up to 80 % time savings when leveling the vehicle

The LEVELING ASSISTANT simplifies the stabilizing process overall by optimally leveling the vehicle. The process itself takes place through pulsating movements of the stabilizer cylinders. With just one lever movement on the remote control, optimal leveling is achieved by pulsating movements of the stabilizers. In order to achieve the best possible vehicle inclination for each individual application, the operator can choose between two versions, „steep position“ or „HPSC“.



HPSC-PLUS*

Maximum utilization of the working area

HPSC-Plus offers three modules to expand the proven stability system HPSC. Due to load detection (LOAD), length measurement system (GEOM) or stabilizer force detection (FSTAB) the lifting capacity of the TEC-range can be fully utilized at every point on the stability curve, regardless of whether space conditions are tight or not.



DUAL POWER SYSTEM (DPS-P / DPS-C)*

Full lifting power for efficient fly jib operation

The Dual Power System enables a significant increase of lifting capacity on the fly jib. The system shows its strengths in the TEC crane with fly jib, especially with large outreach, and increases the areas of application. While DPS-Plus recognizes two positions of the last extension boom and uses two pressure ranges, DPS-C can continuously select the pressure range that suits the respective position and get even more lifting power out of the TEC crane at any time.



P-FOLD*

Perfectly ready for use with just one lever

The P-Fold assistance system makes folding and unfolding a breeze for the operator. With just one lever movement, the TEC crane can be laid apart and folded up again quickly and without damage. This reduces set-up time to a minimum. The RTC (Rope Tension Control) system is an ideal addition if a rope winch is existing.



SMART CONTROL*

Precise crane tip control with just one lever instead of individual ones to control functions

SMART CONTROL is the innovative and easier way to control the crane tip horizontally, vertically and diagonally in all directions with just one lever movement. The system recognizes by itself heavy loads on the hook and automatically compensates the deflection of the crane. This means that precise work can be carried out even more comfortably. The fly jib can be controlled as usual. This makes controlling a crane much easier.



MEMORY POSITION*

Storage of up to 4 crane positions for more efficient work

With MEMORY POSITION, the operator can save defined crane positions including fly jib and rope winch for each operation and approach them exactly by using only one or two levers. Regardless of whether previously saved without a load and then start up again with a load, the system automatically compensates for the respective deflection. Positions that are often the same, like above the loading area of the truck, can also remain saved and do not have to be set new each time.



CONTINUOUS SLEWING SYSTEM

Unrestricted Movement

The continuous slewing system offers full flexibility and efficiency during every operation. This feature enables faster unloading, as the crane can be slewed to the desired position using the shortest possible route. This means working in almost any direction without having to reposition the vehicle.



SRC & RTC*

More comfort in rope winch operation

The Synchronized Rope Control (SRC) maintains the distance between pulley head and hook blocks constant while the crane is being operated. In this way, the operator always has the certainty that the distance to the load remains constant. The Rope Tension Control (RTC) extends operator comfort by automatically controlling the rope length at any time and at any position. The combination of these two systems significantly increases the comfort for the operator and also increases the efficiency of each rope winch operation.



AOS*

Oscillation-free work

Active Oscillation Suppression (AOS) is a patented assistance system from PALFINGER, which compensates vibrations and shocks in the vertical direction during crane operation. This reduces backswing to a minimum and ensures a consistently high standard of safety when transporting a load or emptying big bags.



MEXT & WEIGH*

Extended gain in safety and comfort

Thanks to the assistance systems MEXT & WEIGH, working is even safer and more comfortable. MEXT monitors the mechanical extensions and integrates them into the overload protection. On the one hand, the out-range is increased and, on the other hand, the maximum load capacity is adapted to the respective extension. WEIGH enables the load to be weighed directly at the crane tip. It is also possible to summarize the last ten loads with the date and time.



BODY BUILDING BY EXPERTS

Know-how and expertise from professionals

PALFINGER body builders and the Mounting Competence Center get the maximum performance out of every TEC crane with a well thought-out vehicle body. Carefully matched individual components create a complete overall solution.



PALFINGER EQUIPMENT

Perfectly coordinated crane tools for more efficient, more comfortable and safer work

We know - our customers are professionals, and professionals will only be satisfied with the best equipment to make TEC cranes a multifunctional solution. No matter what the application is, if required, we have the right equipment for the perfect overall solution.

STRONG SERVICE PARTNER WORLDWIDE





A STRONG NETWORK FOR BIG TASKS

For PALFINGER, as a premium manufacturer, service means more than technical support, service is our promise of quality. Our partners are continuously trained and evaluated to count always on the highest service quality. We take care of the fastest possible availability of spare parts and the development of digital tools that make everyday working life easier. Your success is important to us. In order to meet the expectations of our customers, our partners and we are around the globe available with around 5,000 service points.

PALFINGER SERVICE CONTRACTS MAXIMIZE YOUR UPTIME

TAILORED TO YOUR NEEDS

To optimize your business performance, by reducing machine downtimes and repairs costs, we offer you the PALFINGER Service Contracts from 1 to 6 years.

	 PURE	 PERFORM	 PRO	 PRIME
Oil Maintenance	●	●	●	●
Regular Service	—	●	●	●
Legal Inspection *	—	●	●	●
Connected Premium**	○	○	●	●
Repair Service	—	—	●	●
Wear Parts Service	—	—	—	●
Monthly Maintenance	—	—	—	○

● Standard ○ Optional — Not available

*Legal inspection subject to country specific laws.
**Hardware to be purchased with product, availability for your product has to be checked.

Our goal is to offer prevention and backup with complete cost transparency. You can plan your expenditure and do not have to worry about unforeseen workshop costs. We simplify your processes and allow you to focus on your core business.

THE BENEFITS AT A GLANCE

- Outsourced service with an authorized PALFINGER workshop
- Boost product uptime with preventive maintenance
- Full control and transparency of ongoing costs
- Increased resale value
- Maximised product turnover
- Reduced product life costs up to 37 % when your product is protected with a full PALFINGER Service Contract
- Extended product service life

LIFTING CAPACITY DIAGRAMS

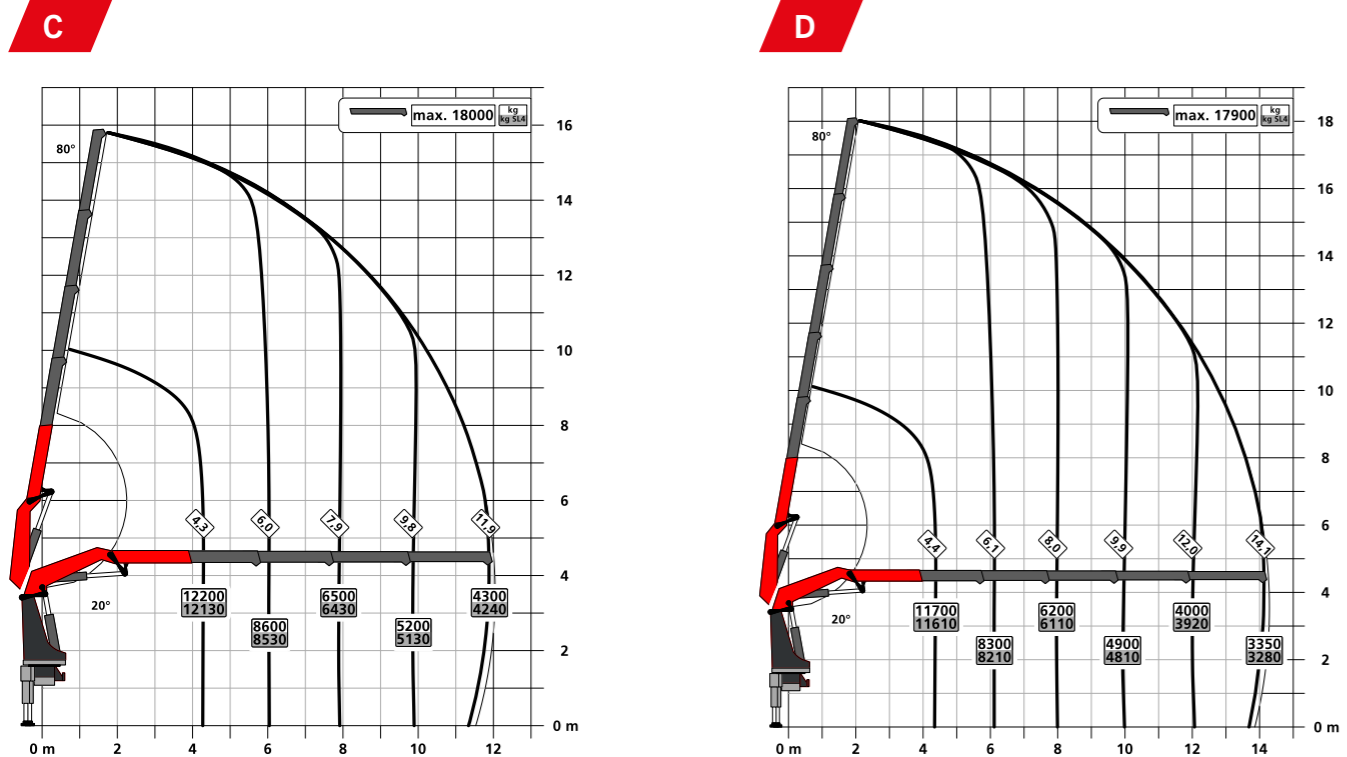

TECHNICAL SPECIFICATIONS

EN 12999 HC1/HD5 S1

Max. lifting moment	55.5 mt/544.8 kNm
Max. lifting capacity	20,000 kg/196.2 kN
Max. hydraulic outreach	21.2 m
Max. outreach with fly jib and mech. extension (JV1)	33.7 m
Slewing angle	continuous
Slewing torque	5.9 mt/57.9 kNm
Stabilizer spread (Std.)	7.8 m
Fitting space required (Std.)	1.44 m
Crane width folded	2.55 m
Max. operating pressure	385 bar
Recommended pump capacity	from 90 l/min to 120 l/min
Dead weight (Std.)	4,670 kg

EQUIPMENT VERSION

STANDARD

- PALCOM P7
- FLOW
- PALTRONIC 180
- Control valve LX-6
- Soft Stop
- High Power Lifting System S-HPLS (+15 %)
- Powerlink Plus
- DPS-Plus at fly jib
- Inclination Angle Monitoring IAM
- Slewing Angle Monitoring SAM
- Boom Angle Monitoring BAM
- Stabilizer Extension Monitoring SEM

OPTIONAL

- LEVELING ASSISTANT
- P-FOLD
- SMART CONTROL
- MEMORY POSITION
- Workman Basket
- Fall Protection Mode FPM
- Active Oscillation Suppression AOS
- High Performance Stability Control HPSC-PLUS LOAD | GEOM | FSTAB
- Synchronised Rope Control SRC
- Rope Tension Control RTC
- Dual Power System Continuous DPS-C at fly jib with BEM
- Mechanical Extension Monitoring MEXT
- Load weighing function WEIGH
- Boom Extension Monitoring BEM
- Multifunction adapter fly jib MFA-J
- Rope winch 2,5 t / 3,5 t

FLY JIB

Version	PJ 090	PJ 150
PK 580 TEC E		C, E
PK 580 TEC F	B, C	C, E
PK 580 TEC G	B, C	

UNBEATABLE OUTREACH WITH FLY JIB

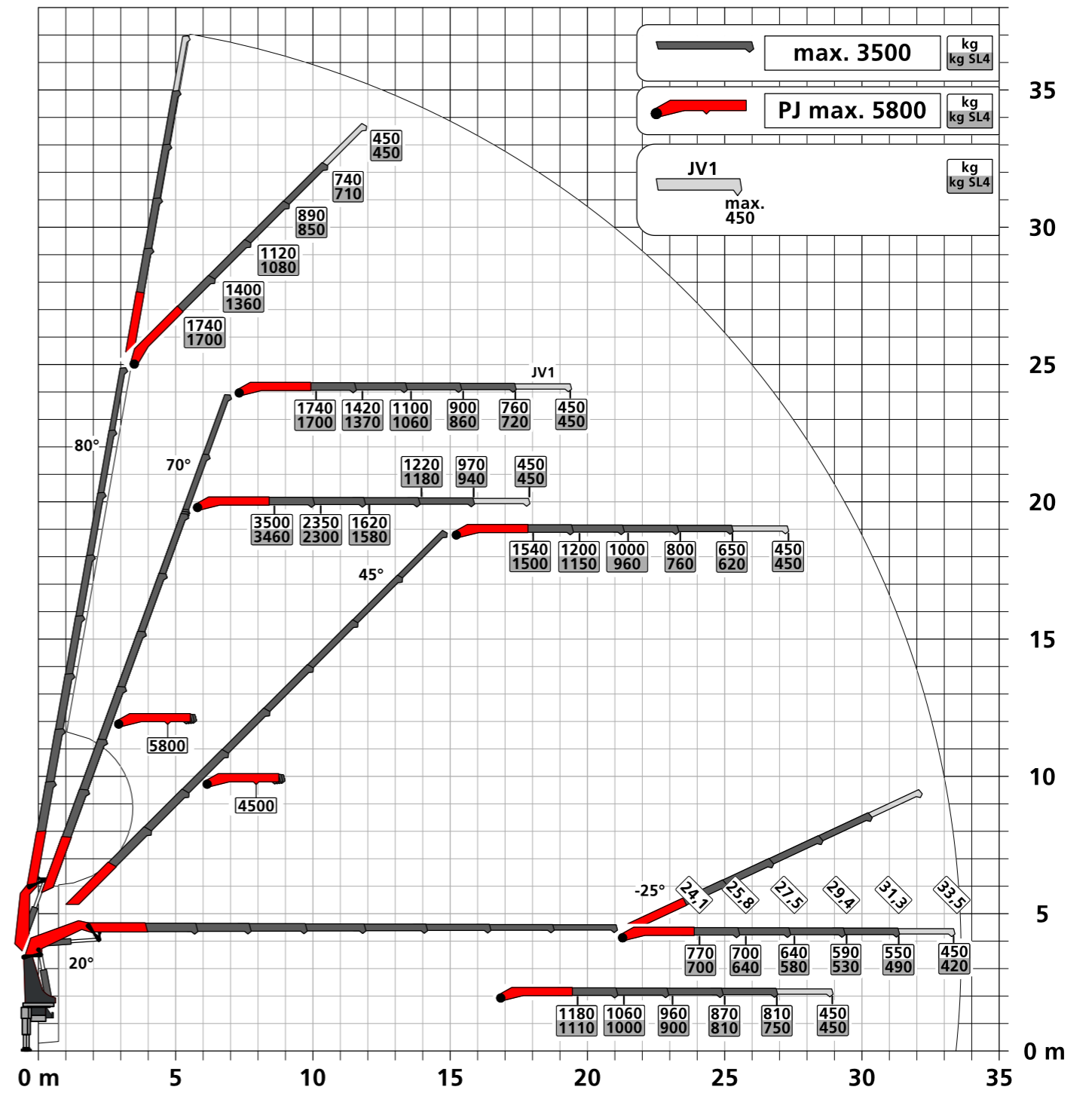
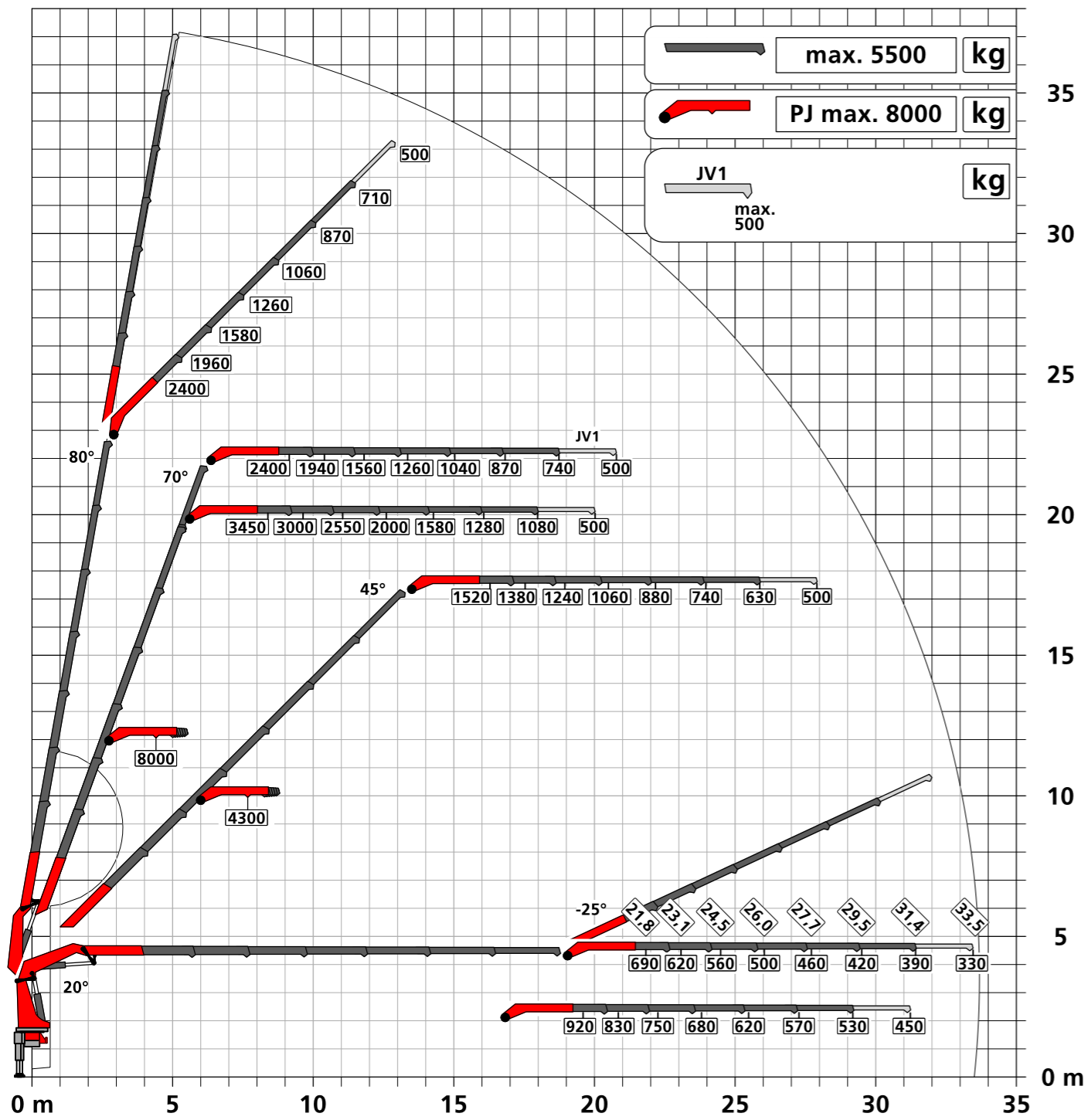

KP-PK580TECM1+EN
12/2022

Cranes shown in the leaflet are partially optional equipped and do not always correspond to the standard version. Country-specific regulations must be observed. Dimensions may vary. Subject to technical changes, errors and translation mistakes.