

SCANIA

PK 24.001 SLD5

G 410 B6X2*4 NB

CONTRACT NUMBER: PALDRIVE 423

NEW

AVAILABLE



SPECIFICATION

PK 24.001 SLD5

- Hydraulic 5-fold extension
- High-speed extension system with return oil recovery
- Swivel range 400°
- Hydraulic support leg extension (max.support width 5,600mm)
- Support legs can be swiveled hydraulically through 180°
- Paltronic 40
- HPSC-E + LOAD + additional ballast function (LCA03)
- Transport monitoring crane and support
- Scanreco radio remote control - 6 functions with cross levers

OFFER INFORMATION

Location details

MCC-NORTH SOLEC, 86-050 - Poland 

Dealer Name

Palfinger EMEA GmbH PL



Availability

Available

Available from

25.03.2019

Product type

New

Contract number

Paldrive 423

Dealer E-mail

sales@palfinger.com

Dealer phone

004366488345792

- Painting RAL3020
- Working lights on the articulated arm
- Hose equipment for two additional devices
- Piston rod protection for the articulated cylinder
- 8.0t load hook

Platform

- 6.200mm x 2.480mm in the clear
- Multifunctional frontwall height: 1650mm + 650mm extension
- Side and rear wall height: 750 mm
- Left and right 2 folding steps each
- 6 rows of lashing rails integrated in the floor
- Flat bottom 27mm Plywoodplates

SCANIA

- G410 B6x2 * 4NB
- 410 HP
- GRS905R Gearbox + opticruise
- Retarder R4100
- Air suspension on all axles
- Fuel tank 350l / AD blue 80l
- Tires 1st and trailing axle 385/65 R22.5
- Drive axle tires 315/80 R22.5
- Cabin color: Ivory White / Chassis color: Sub Gray

PRODUCT

Manufacturer	Palfinger	Lifting moment	20,9 mt
Model	PK 24.001 SLD5	Outreach / Lifting power	14,8m / 1.180 Kg
Construction year	2023	Max outreach	14,8m

TRUCK

Truck manufacturer	SCANIA	Axes	6*2*4
Construction year	2023	Gross vehicle weight	26.000 Kg
Drivers cabine	CG17N	Dead weight	14.300 Kg
Wheel base	4.750 mm	Payload	11.700 Kg
Power	410 PS	Payload category	6t - 15t
Emmission standard	EURO 6	Construction	Crane and platform

Konstruktionsänderungen vorbehalten, fertigungstechn. Toleranzen müssen berücksichtigt werden.

Krandarstellung symbolisch



**PK 21.501 SLD 1 | PK 24.001 SLD 5 |
PK 21.501 SLD 3**

**RELIABLE
PARTNER FOR
EVERYDAY USE**

LIFETIME EXCELLENCE



ABILITY TO WORK EFFICIENTLY AT THE HIGHEST LEVEL

The SLD models of the 21 to 24 meter-ton category are ideally suited for everyday and, above all, easy loading operations. Thanks to standard features, such as the so-called High Speed Extension, the work can be done quickly and economically. The cranes achieve their good lifting performance thanks to the combination of the boom system with conventional hexagonal profile with a knuckle joint and the Paltronic, a control electronics, developed by PALFINGER. The applications can be varied: from the transport of classical building materials to special pumps for water treatment and beyond.

But one thing all PALFINGER cranes have in common is that our customers and perhaps you will also appreciate in the future: They stand for LIFETIME EXCELLENCE – top performance without compromise for a product lifetime.





LIFTING CAPACITY DIAGRAMS

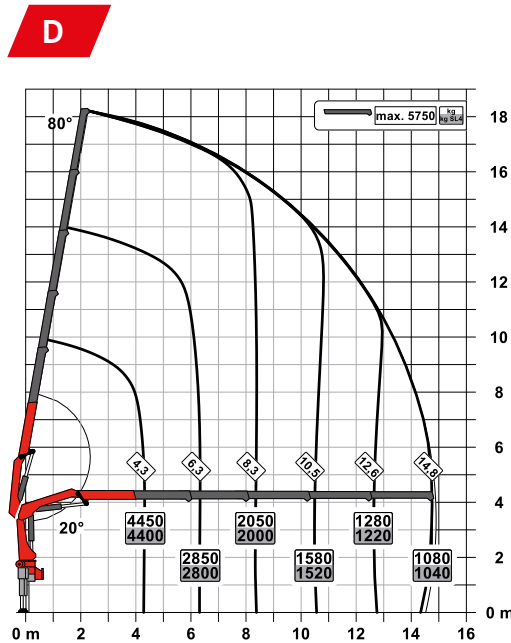

MODEL LINE SLD 1 (NON-CE)

- Single Link Plus
- Optional:
 - Overload protection OSK
 - Top seat control
 - High stand control
 - Radio remote control
- NON-CE model

TECHNICAL SPECIFICATIONS

EN 12999 HC1 HD4/S2

Max. lifting moment	20.9 mt / 205.2 kNm	151,290 ft.lb
Max. lifting capacity	6200 kg / 60.8 kN	13,700 lb
Max. hydraulic outreach	14.9 m	48' 11"
Max. manual outreach	19.1 m	62' 4"
Slewing angle	400°	
Slewing torque	2.3 mt / 23.0 kNm	16,960 ft.lb
Stabiliser spread (std./max.)	5.0 m / 7.4 m	16' 5" / 24' 3"
Fitting space required (std.)	0.91 m	2' 12"
Width folded	2.50 m	8' 2"
Max. operating pressure	330 bar	4,785 psi
Recommended pump capacity	from 45 l/min to 60 l/min	11.9 US gpm 15.9 US gpm
Dead weight (std.)	2250 kg	4,960 lb



LIFTING CAPACITY DIAGRAMS

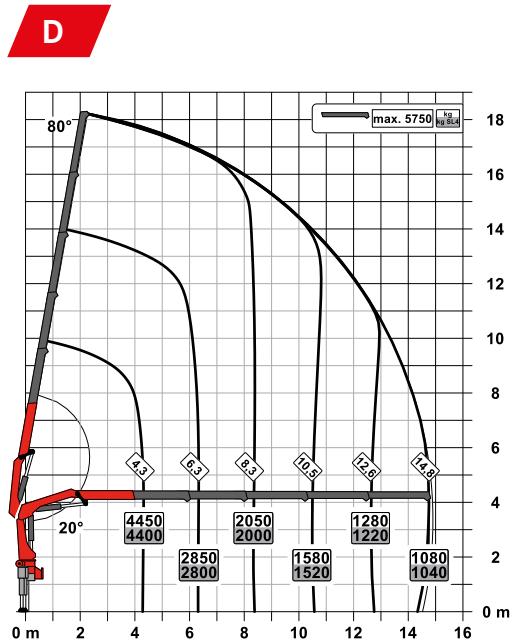
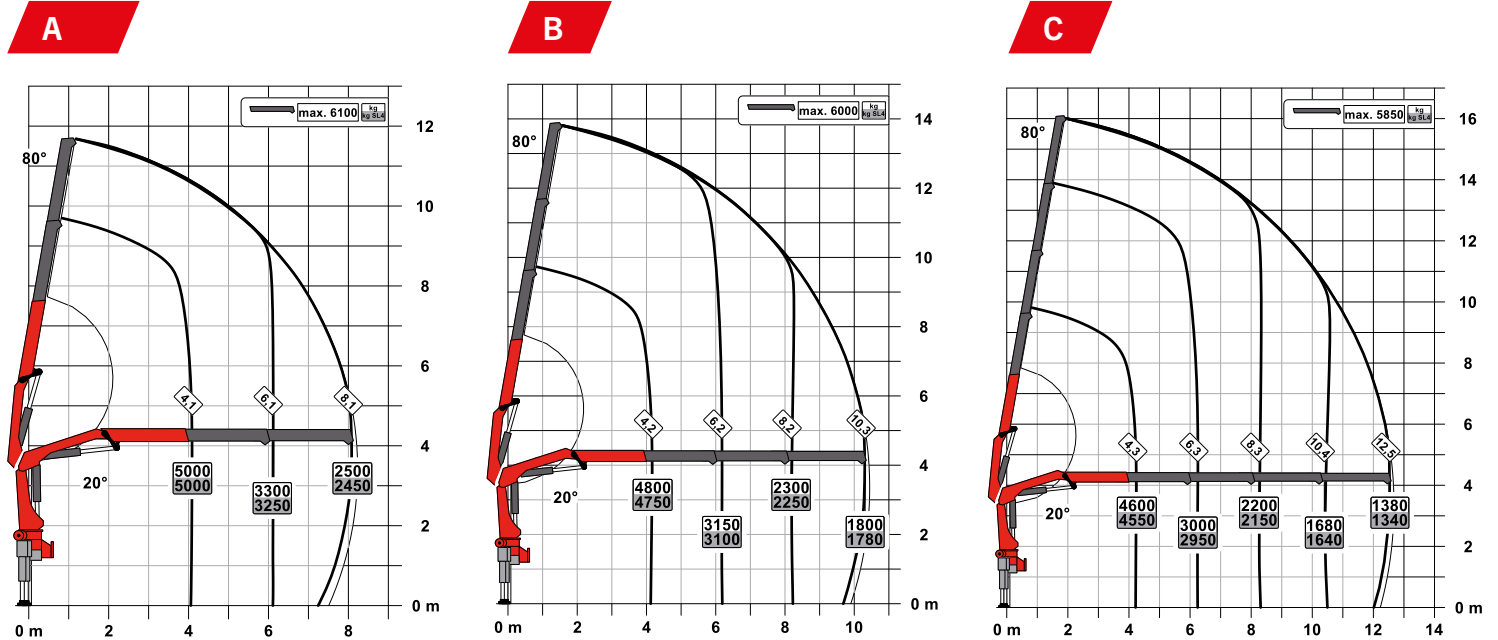

MODEL LINE SLD 3

- Single Link Plus
- Paltronic overload protection
- Optional:
 - Stability monitoring system ISC-S (standard for CE), HPSC-L, HPSC-E
 - High stand control
 - Radio remote control
 - Rope winch 2.5t on the knuckle boom
 - Rigid stabilizer BS001
- NON-CE and CE model

TECHNICAL SPECIFICATIONS

(EN 12999 HC1 HD4/S2)

Max. lifting moment	20.9 mt / 205.2 kNm	151,290 ft.lb
Max. lifting capacity	6200 kg / 60.8 kN	13,700 lb
Max. hydraulic outreach	14.9 m	48' 11"
Max. manual outreach	19.1 m	62' 4"
Slewing angle	400°	
Slewing torque	2.3 mt / 23.0 kNm	16,960 ft.lb
Stabiliser spread (std./max.)	5.0 m / 7.4 m	16' 5" / 24' 3"
Fitting space required (std.)	0.91 m	2' 12"
Width folded	2.50 m	8' 2"
Max. operating pressure	330 bar	4,785 psi
Recommended pump capacity	from 45 l/min	11.9 US gpm
	to 60 l/min	15.9 US gpm
Dead weight (std.)	2250 kg	4,960 lb



CINTWELL

Commercial Equipment
+ 121 7014 884138
www.cintwell.co

LIFTING CAPACITY DIAGRAMS

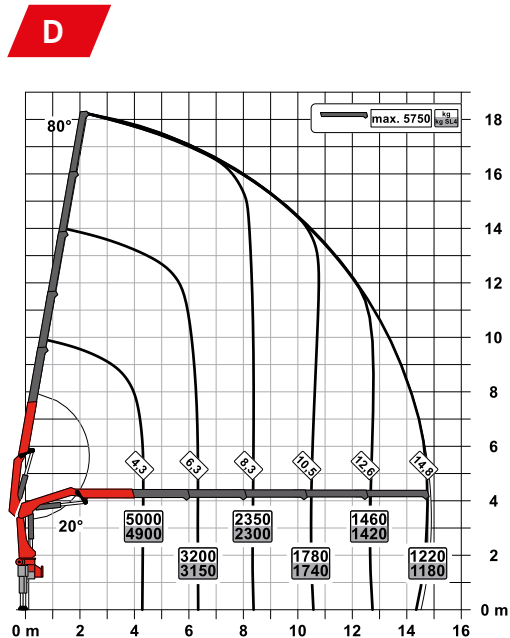

MODEL LINE SLD 5

- Single Link Plus
- Paltronic overload protection
- A-HPLS
- Load Sensing valve
- Radio remote control with LED display
- Optional:
 - Stability monitoring system ISC-S (standard for CE), HPSC-L, HPSC-E
 - Rope winch 2.5t on the knuckle boom
 - Rigid stabilizer BS001
- NON-CE and CE model

TECHNICAL SPECIFICATIONS

(EN 12999 HC1 HD4/S2)

Max. lifting moment	23.1 mt / 226.5 kNm	167,000 ft.lb
Max. lifting capacity	6200 kg / 60.8 kN	13,700 lb
Max. hydraulic outreach	14.9 m	48' 11"
Max. manual outreach	19.1 m	62' 4"
Slewing angle	400°	
Slewing torque	2.3 mt / 23.0 kNm	16,960 ft.lb
Stabiliser spread (std./max.)	5.0 m / 7.4 m	16' 5" / 24' 3"
Fitting space required (std.)	0.91 m	2' 12"
Width folded	2.54 m	8' 2"
Max. operating pressure	360 bar	5,220 psi
Recommended pump capacity	from 65 l/min to 90 l/min	17.2 US gpm to 23.8 US gpm
Dead weight (std.)	2250 kg	4,960 lb



SINGLE LINK PLUS

The knuckle joint on the crane's knuckle boom improves the lifting power significantly. This knuckle boom, which has been specially developed by PALFINGER and can be angled upwards, also stands out by virtue of excellent movement geometry. Difficult crane jobs can be performed with precision even in the tightest spaces.



COATING TECHNOLOGY

Top quality surface protection at a glance

The KTL coating lays the foundation for a perfect surface protection. Afterwards the components are either coated in the powder-coating facility or are finished with a two-components-topcoat. High value retention and excellent corrosion protection for the whole life of a crane.

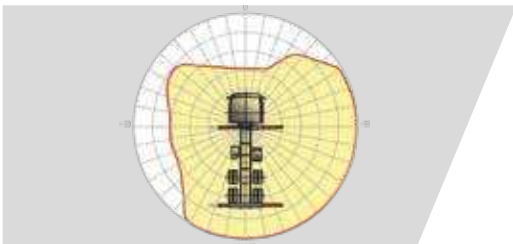

HPSC*

Maximum utilisation of the working range

The variable stabiliser positioning of the High Performance Stability Control System makes it possible to utilise the lifting capacity to the maximum. It enables working within tight spaces.



HPSC-PLUS LOAD*

Longer reach due to load detection

HPSC-Plus LOAD is an additional module, extending the stability system HPSC. Thanks to inclination monitoring, lifting capacity can be maximized using the truck's load.



PALTRONIC

Comfort and safety

The Paltronic, PALFINGER offers the latest control electronics for the series production crane. The custom designed electronic operates and monitors the crane and offers more efficiency in use and safety.



RADIO REMOTE CONTROL*

Dialogue with the operator

PALFINGER radio remote controls are equipped with linear lever or cross lever and provide the greatest possible comfort for the operator. All SLD models with LED-Display inform the crane operator about the different operating conditions.



CONTROL CONSOLE

All information at a glance

All important information about the crane can be seen on the main control stand. A digital indicator counts and displays the operating hours. Ergonomic control levers and the optional lighting package provide increased safety and comfort even in poor visibility conditions..



HOSE EQUIPMENT FOR ATTACHMENTS*

Versatile and user-friendly

The hose equipment offers an easy means of connecting auxiliary equipment. The hose equipment is guided in hose trays for protection



LIGHTING PACKAGE*

More crane safety particularly at dusk and dark

LEDs which backlight the control panel make it easier to read off the crane functions and provide the crane operator with a quick overview of the entire panel during the working process. LED warning lights in the supporting cylinders mean greater safety for crane operator and passers-by.

