

MERCEDES

P 220 BK

BENZ SPRINTER 315 CDI 4X2

CONTRACT NUMBER: P220BK STANDARD

NEW

ON STOCK

AVAILABLE NOW



SPECIFICATION

OFFER INFORMATION

Location details

Löbau, 02708 - Germany 

Dealer Name

Palfinger Platforms GmbH

Product type

New

Contract number

P220BK Standard

Dealer E-mail

sales.platforms@palfinger.com

Dealer phone

004935854796121

- 4 Safety-Spreader plates incl. bracket on the platform covering
- Covers made of aluminium chequer plate
- Home-Function
- Operator control panel in cage (optional display possible)
- Stabilizer control panel at the base
- Automatic stabilizer levelling system
- Three stabiliser configurations: jacking within vehicle width, wide jacking and one-side wide jacking and automatic release of the related workspace
- 1x user manual, signs, display language (if display is present) in country specific language
- 230V/10A CEE-socket incl. supply with residual current circuit breaker at the base
- 230V CEE-socket at cage
- Additional CEE-socket supplied by on-board voltage
- Cleaning hatch at cage
- Self-closing door for upright entrance to the cage
- 2 anchor points for safety harnesses
- PALDiag for system analysis, integrated in platforms software

Painted in MB9147 arctic white

PRODUCT

Manufacturer	PALFINGER	Basket size	1,40 x 0,70 x 1,10 m
Model	P 220 BK	Basket capacity	300 kg
Construction year	NEU - NEW	Basket turning device	+/- 90°
Outreach	16,9 m	Basket arm angle	185°
Max. height of work	22,0 m	Basket material	Aluminium
Turret rotation	500°		

TRUCK

Truck manufacturer	Mercedes Benz	Power	110 kW (150 PS)
Vehicle type	Sprinter 315 CDI	Emmission standard	EURO 6
Construction year	NEU - NEW	Axes	4x2
Wheel base	3.665 mm	Gross vehicle weight	3.500 kg

PALFINGER

P 220 BK

AGILE AND COMPACT

LIFETIME EXCELLENCE

PALFINGER P 220 BK

HIGHLIGHTS

- Stabiliser operation from the base for easy and safe support
- Robust aluminium workman basket with 3000 kg cage load and integrated anti-squeeze protection function in the knee rail
- Automatic support stabilising with wheel clearance monitoring
- Flat substructure under the workman basket allows users to get as close to obstacles as possible
- Full range with vertical support on large chassis (7.5t)

STANDARDS













- Home function
- Automated positioning system
- Safety plates
- 230V CEE current supply with CEE socket in the workman basket
- European type approval
- Stabiliser control at basis

OPTIONS

- Tree maintenance package (tree basket, wooden edge, protective roof, chainsaw mount)
- Protective grating above cab
- Display at the base, including height limitation
- Display in the workman basket, including adjustment of ramps
- Aluminium edging
- Dual insulation with plastic basket



TECHNICAL SPECIFICATIONS

	Total weight *	3330 kg		max. outreach	16.90 m
	Overall length	7.40 m		Rotation angle of turntable	500°
	Width in transport position	2.22 m		Rotation angle of cage	2 x 90°
	Height in transport position	2.99 m		Rotation angle of cage boom	185°
	max. stabiliser width	3.60 m		Size of cage	1.40 x 0.70 x 1.10 m
	max. working height	22 m		max. cage load	300 kg
	max. cage bottom height	20 m			

* Depends on truck chassis

WORKING DIAGRAMS

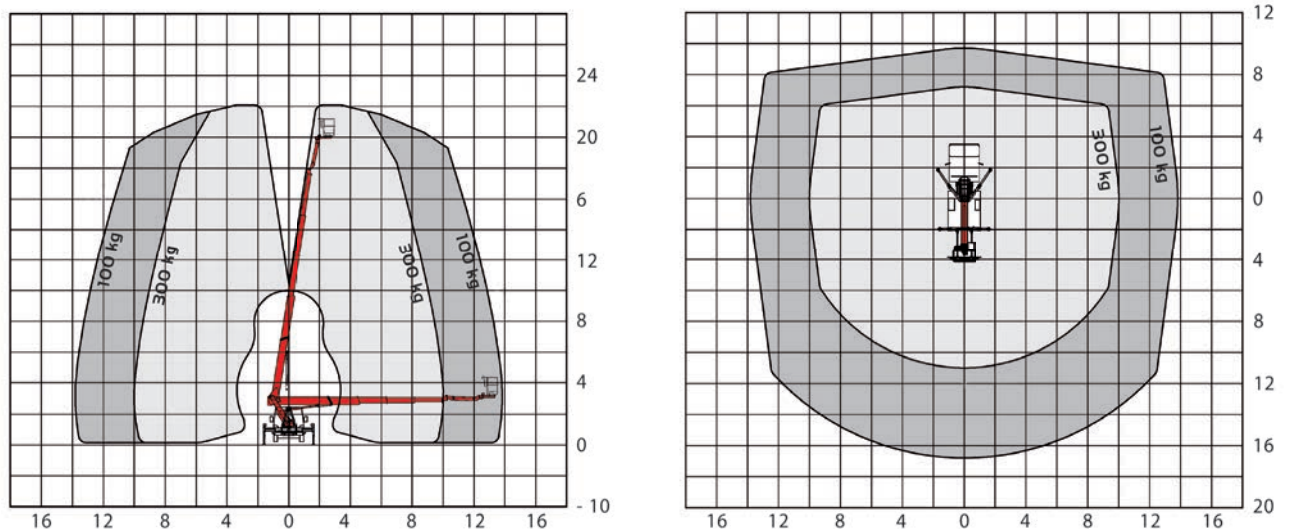

A possible 2% tolerance is contingent on structural component

DIMENSIONS

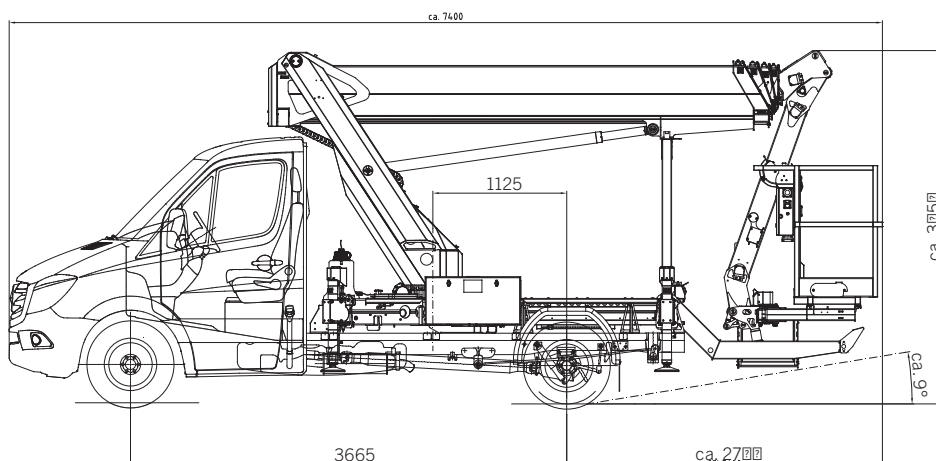

YOUR CONTACT

Palfinger Platforms GmbH
Düsseldorfer Str. 100
47809 Krefeld | Germany

KP-P220BKM1+EN

Units shown in the leaflet are partially optional equipped and do not always correspond to the standard version. Country-specific regulations must be observed. Dimensions may vary. Subject to technical changes, errors and translation mistakes.

Platforms | Area sales Manager



Head of sales
Michael Gruböck



Laura Garagnani
Responsible Areas:
France, Portugal, Spain



Timo Lenzen
Responsible Areas: Norway, Sweden, Finland, Island, Denmark, Faroe Islands, Latvia, Lithuania, Estonia, Czech Republic, Poland, Ukraine, Moldova



Adnan Isso
Responsible Areas:
Netherlands, Belgium, Luxembourg



Mohammed AlNajmi
Responsible Areas: Slovenia, Croatia, Greece, Cyprus, Serbia, Bosnia, Kosovo, Montenegro, Albania, Macedonia, Israel, Turkey, Georgia, Syria, Lebanon, Jordan, Iraq, Iran, Afghanistan, Saudi Arabia, Kuwait, Bahrain, Qatar, UAE, Oman, Yemen



Dieter Schlosser
Responsible Areas:
Switzerland, Slovakia, Hungary, Romania, Bulgaria, Australia, New Zealand, Georgia, Ireland, United Kingdom



Johann Poschner
Responsible Areas:
Germany, Austria



ALFREDO CAREDDU
Responsible Areas:
Italy, Malta



Mohammed AlNajmi
Responsible Areas:
Africa

