

MAN

**P 300 KS**

**TGL 8.160 4X2 BB**

CONTRACT NUMBER: P300KS STANDARD

NEW

IN PRODUCTION



## SPECIFICATION

## OFFER INFORMATION

Location details

Löbau, 02708 - Germany 

Dealer Name

Palfinger Platforms GmbH

Product type

New

Contract number

P300KS Standard

Dealer E-mail

[sales.platforms@palfinger.com](mailto:sales.platforms@palfinger.com)

Dealer phone

**004935854796121**

- Fully variable stabilizer system
- Automatic stabilizer levelling
- Possibility of driving the chassis with jib set up and main boom settled on the rest
- Home-Function
- Memory-Function
- Disconnection of movements, when cage hits an obstacle
- Central energy supply at the cage (24V) and external 230 V CEE-plug-in on the base and CEE- plug in the cage (incl. HFI-switch)
- Aluminum bordering, both sides hinged
- Automatic adjustment of outreach due to monitoring inclination of MEWP
- 4 Safety-Spreader plates incl. bracket
- Color display for basket control
- Preparation for ground bolt
- Engine start stop function from control stands
- Battery monitoring incl. warning signal
- Illumination of all stabilizer and platform control elements for easier working at bad visual conditions
- CE-conformity, declaration of conformity, inspection book
- Emergency control panel
- Wide Cage turning range to approach inaccessible working spots through comfortable positioning of the cage

Painting in RAL9010 pure white

**PRODUCT**

<b>Manufacturer</b>	PALFINGER	<b>Basket size</b>	1,80 x 1,00 x 1,10 m
<b>Model</b>	P 300 KS Facelift	<b>Basket capacity</b>	400 kg
<b>Construction year</b>	NEU - NEW	<b>Basket turning device</b>	+/- 85°
<b>Outreach</b>	20,5 m	<b>Basket arm angle</b>	195 °
<b>Max. height of work</b>	30,0 m	<b>Basket material</b>	Aluminium
<b>Turret rotation</b>	540 °		

**TRUCK**

<b>Truck manufacturer</b>	MAN	<b>Wheel base</b>	3.050 mm
<b>Vehicle type</b>	TGL 8.160 4x2 BB	<b>Power</b>	118 kW / 160 PS
<b>Construction year</b>	NEU - NEW	<b>Emmission standard</b>	EURO 6
<b>Drivers cabine</b>	C	<b>Axes</b>	4x2
		<b>Gross vehicle weight</b>	7.490 kg

**PALFINGER**

**P 300 KS FACELIFT**

**COMFORT LIKE  
NEVER BEFORE**

**LIFETIME EXCELLENCE**





## HIGHLIGHTS

- 30m working height with 400kg cage load
- Powerlift-System with max. 300kg payload, 150kg per load cross beam/boom
- Improved performance data of minimal mode: 10° movement to the left and right with full jib manoeuvrability, operations at 8 meters working height without stabilizers
- Improvement of ergonomics: optimized underrun protection due to enlarged control boxes as well as improved slope angle
- Stabilizer operation from the base at the left and at the right side
- Convenient access to the working cage
- Thanks to the fully variable stabilizer system, the stabilizers can be positioned precisely, even on uneven terrain with 730mm stroke and up to 5° of inclination
- The shortest overall length and wheelbase in this class (3050mm) ensures good manoeuvrability

## STANDARDS













- Home function
- Memory function
- Foldable Aluminium bordering enable easy transport of bulky parts
- Cage load measurement device
- Cage exchange system - enables an easy and quick exchange of aluminium and fiberglass working cages
- Automatic adjustment of outreach due to monitoring of the platform's inclination. Fast, safe working despite vehicle inclination.
- 4 Safety spreader plates
- Battery voltage monitor
- Emergency control panel
- 230V CEE power supply with CEE socket in the workman cage

## OPTIONS

- Protection guard on top of driver's cab
- Dividing screen with bracket at the main boom rest and in the cage
- Wooden frame on the cage
- Bracket for chainsaw
- Bracket for 7 traffic cones mounted on the chassis covering
- Airline rails at the bordering incl. 4 fittings
- Vertical parallel drive of the cage
- 2 covers for warning beacons at the turntable and at the main boom rest
- 4 working lights mounted at the basic frame to illuminate the outrigger areas
- 2 working lights mounted on the left and right side at the main boom rest to illuminate the surrounding
- Short rear underrun protection (with integrated rear lighting)
- Electric emergency pump
- Device for checking axle-position for both axles, with one sensor per tyre each
- Insulation package in combination with aluminium cage: Double insulation against 1000V according to DIN VDE 0682-742.
- Possibility of mounting on all-wheel drive or standard chassis of various manufacturers and weight classes with optimized jack-up widths



## TECHNICAL SPEZIFICATIONS

	Total weight*	7490 kg		max. outreach *	20,50 m
	Overall length	7,60 m		Rotation angle of turntable	540°
	Width in transportposition	2,52 m		Rotation angle of cage	+/-85°
	Height in transportposition	3,50 m		Rotation angle of cage boom	195°
	max. stabiliser width	5,00 m		Size of cage	1,80 x 1,0 x 1,10 m
	max. working height	30 m		max. cage load	400 kg
	max. cage bottom height	28 m			

\* Depends on truck chassis

## WORKING DIAGRAMS

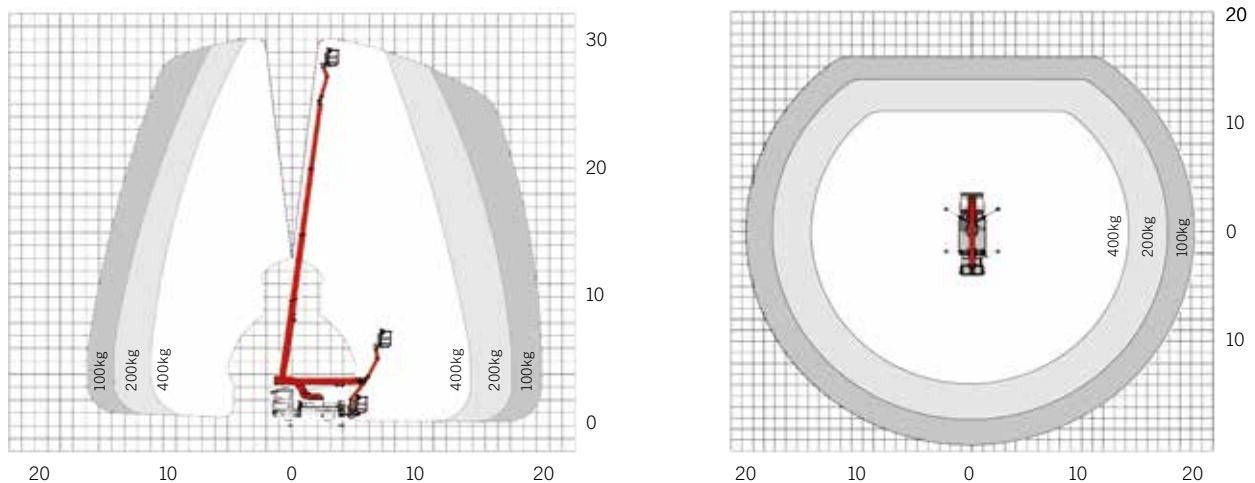

A possible 2% tolerance is contingent on structural components

## DIMENSIONS

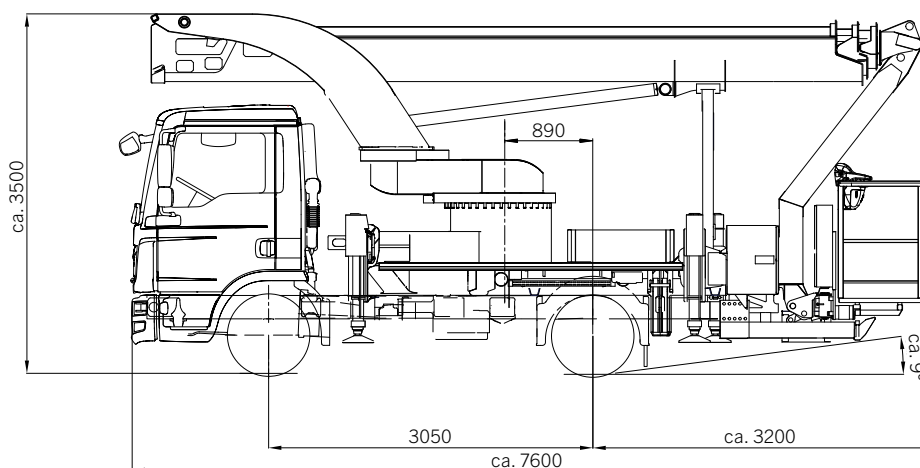

## **YOUR CONTACT**

**Palfinger Platforms GmbH**

Düsseldorfer Str. 100  
47809 Krefeld | Germany

KP-P300 KSM3 +EN

Units shown in the leaflet are partially optional equipped and do not always correspond to the standard version. Country-specific regulations must be observed. Dimensions may vary. Subject to technical changes, errors and translation mistakes.

Platforms | Area sales Manager



**Head of sales**  
Michael Gruböck



Laura Garagnani

**Responsible Areas:**  
France, Portugal, Spain



Timo Lenzen

**Responsible Areas:** Norway, Sweden, Finland, Island, Denmark, Faroe Islands, Latvia, Lithuania, Estonia, Czech Republic, Poland, Ukraine, Moldova



Adnan Isso

**Responsible Areas:**  
Netherlands, Belgium, Luxembourg



Mohammed AlNajmi

**Responsible Areas:** Slovenia, Croatia, Greece, Cyprus, Serbia, Bosnia, Kosovo, Montenegro, Albania, Macedonia, Israel, Turkey, Georgia, Syria, Lebanon, Jordan, Iraq, Iran, Afghanistan, Saudi Arabia, Kuwait, Bahrain, Qatar, UAE, Oman, Yemen



Dieter Schlosser

**Responsible Areas:**  
Switzerland, Slovakia, Hungary, Romania, Bulgaria, Australia, New Zealand, Georgia, Ireland, United Kingdom



Johann Poschner

**Responsible Areas:**  
Germany, Austria



ALFREDO CAREDDU

**Responsible Areas:**  
Italy, Malta



Mohammed AlNajmi

**Responsible Areas:**  
Africa

