

VOLVO

**P 750**

**FM 460 HP 8X4 BL**

CONTRACT NUMBER: 11750050

NEW

IN PRODUCTION



## OFFER INFORMATION

Location details

Löbau, 02708 - Germany 

Dealer Name

Palfinger Platforms GmbH

Product type

New

Contract number

11750050

Dealer E-mail

[sales.platforms@palfinger.com](mailto:sales.platforms@palfinger.com)

Dealer phone

**004935854796121**

## SPECIFICATION

- Ergonomic access within width of chassis, build as standard on right hand side
- non-slip safety plates incl. holders at chassis, vertically mounted
- Aluminum side panels with flappable walls left and right
- Quick access to MEWP data via QR-Code in working basket
- Illuminated electric and hydraulic boxes
- Illuminated ergonomic access
- Lubrication system for lower telescope arm at P570, P640, P750
- Black visible cylinders as standard in RAL9005
- Covers out of corrugated sheet aluminum
- Lockable groundbracket on basis with crossgroundtube and cable (10m - 70mm<sup>2</sup>)

- Automatic set up function upper boom.  
Basket could be in front of, beside of or behind of MEWP
- Touch-Display chassis cabin for self-diagnostic from error-codes, partly steering of all functions of MEWP, status view of operational readiness
- Oil cooler for best working temperatures
- Extended memory-function, saves the position for two positions
- Home-Function
- Oil control with display in chassis cabin
- Touch down safety equipment for basket on ground with KLM
- Safety function for ergonomic access, detected by sensor
- Hydraulic telescopic basket, incl. interface for power lift system
- Shroud with possibility to hang on straps for load securing
- Color display for basket control
- 4 attachment points for hauling on basic frame; handling KIT
- Reversing camera mounted on rear of chassis, activated with reverse gear, shown in display in cabin
- Adjustable time before dead man's switch is activated
- Wind gauge at basket rotating device; wind speed will be shown in color display
- Automatic levelling system w/o attachment for sensoring free tyres
- 2 storage boxes for work equipment, waterproof, lockable, out of plastic
- Operation data acquisition device (Company Rösler miniDaT-WEB-EX-P), not applicable in all countries (USA, India, Australia). Partly applicable in Switzerland.

- Second control unit at the rear of chassis / electrical emergency operation at the base
- Stageless adjustment of the working range for inclined set up`s
- 1x operation instruction, signs, display language (when display exists) in country-specific language
- Working diagram in basket and second control unit at the rear of chassis
- 400V CEE and 230 V earthed safety socket incl. earth fault circuit interrupter and CEE supply at the base
- Schuko plug-in 230V plus CEE-plug-in 400V
- 24V plug-in in basket
- Permanent floor pressure monitoring on all outriggers for device approval and during operation
- Cleaning opening in basket
- Self-locking door for vertical entry into the workman basket
- 7 eyelets for attaching the safety belts (PSE)
- PALDiag for self-diagnostic, integrated in MEWP software

Painting in RAL9010 pure white

**PRODUCT**

<b>Manufacturer</b>	PALFINGER	<b>Turret rotation</b>	540°
<b>Model</b>	P 750	<b>Basket size</b>	3,88 x 1,05 x 1,10 m
<b>Construction year</b>	2024	<b>Basket capacity</b>	max. 600 kg
<b>Outreach</b>	max. 39,00 m	<b>Basket turning device</b>	+/- 200°
<b>Max. height of work</b>	75,00 m	<b>Basket material</b>	ALU

**TRUCK**

<b>Truck manufacturer</b>	Volvo	<b>Power</b>	469 PS/345 kW
<b>Vehicle type</b>	FM 460	<b>Emmission standard</b>	EURO 6
<b>Drivers cabine</b>	FM-DAY	<b>Axes</b>	8x4
<b>Wheel base</b>	5600 mm	<b>Gross vehicle weight</b>	32.000 kg
		<b>Construction</b>	Hubarbeitsbühne

**P 750**

# **SENSATIONAL WORKING HEIGHT**

**LIFETIME EXCELLENCE**

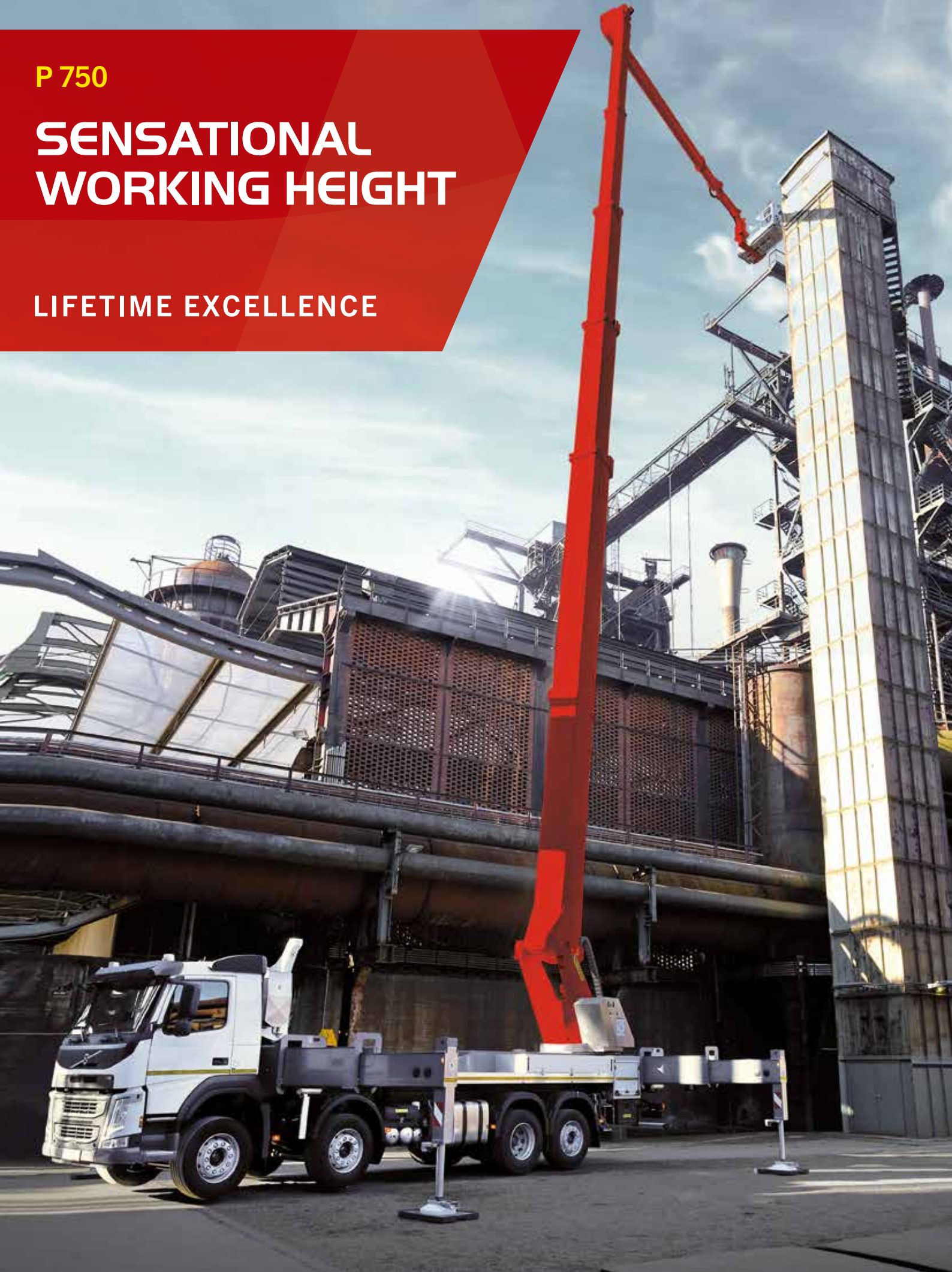

## HIGHLIGHTS

- Greater working range thanks to 240° X-jib
- 2 x 200° basket rotation for perfect positioning of the workman basket
- Telescopic upper boom up to 19 m total length
- Automatic telescope lubrication system supplies the lower boom telescopes with grease during platform operation
- Telescopic basket with up to 600 kg basket load and integrated preparation for Powerlift-System
- Hanging basket enables operators to work close to objects

## STANDARDS













- Rear view camera
- Memory-Function
- Automated positioning system
- Telescopic basket
- Driver information system
- Safety spreader plates
- 230 V CEE current supply with CEE socket in the workman cage
- Assistance systems

## OPTIONS

- Powerlift-System: Transport device for working material with max. 600 kg payload to be carried externally on the basket.
- Material handler/crane in basket for lifting objects from the Powerlift and direct assembly at the place of use (400 kg payload).
- Telescopic camera basket with 600 kg basket load including mount for film illumination
- Ultrasonic sensors to protect the workman basket from collisions
- Mobile radio remote controls for access platform and stabilizer operation
- Access from both sides (access ladder on right and left-hand side) with lighting



## TECHNICAL SPECIFICATIONS

	Total weight *	32200 kg		max. outreach	39 m
	Overall length	14.10 m		Rotation angle of turntable	540°
	Width in transportposition	2.54 m		Rotation angle of cage	2 x 200°
	Height in transportposition	3.95 m		Rotation angle of cage boom	240°
	max. stabiliser width	8.89 m		Size of cage	3.88 x 1.05 x 1.10 m
	max. working height	75 m		max. cage load	600 kg
	max. cage bottom height	73 m			

\* Depends on truck chassis

## WORKING DIAGRAMS

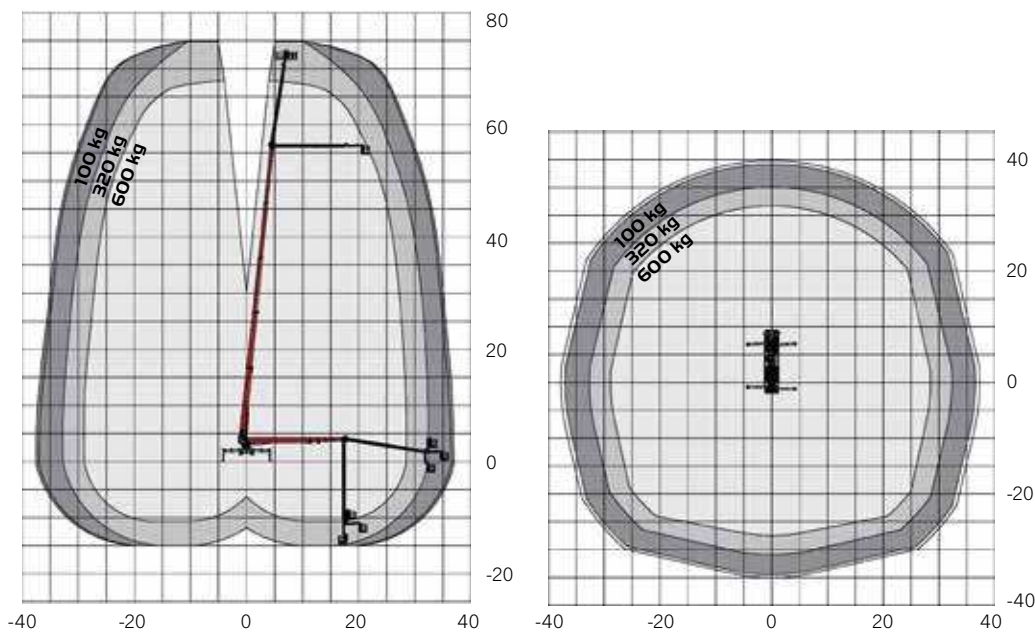

\* A possible 2% tolerance is contingent on structural components

## DIMENSIONS

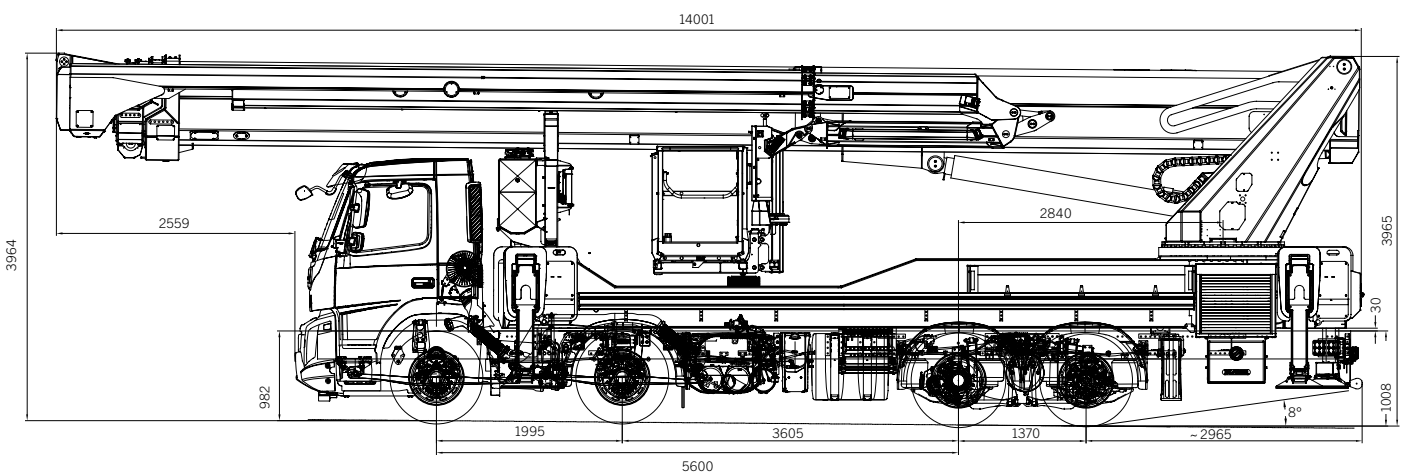

## **YOUR CONTACT**

**Palfinger Platforms GmbH**

Düsseldorfer Str. 100  
47809 Krefeld | Germany

KP-P750M2+EN

Units shown in the leaflet are partially optional equipped and do not always correspond to the standard version. Country-specific regulations must be observed. Dimensions may vary. Subject to technical changes, errors and translation mistakes.