

MAN

**PK 19.001 SLD5**

**TGS 26.470 6X2-4 LL**

CONTRACT NUMBER: PALDRIVE 371

NEW

AVAILABLE



## SPECIFICATION

**MAN + PK 19.001 SLD5 + Palfinger  
Installation**

Available within 2 weeks from order

**360° Vehicle stability on 100%**

**Crane performance**

### PK 19.001 SLD5

- Hydraulic 4-fold extension
- High-speed extension system with return oil recovery
- Swivel range 420°
- Hydraulic support leg extension (max.support width 6.600mm)

Prior sale and changes reserved!

## OFFER INFORMATION

Location details

MCC-NORTH SOLEC, 86-050 - Poland 

Dealer Name

Palfinger EMEA GmbH PL

**PALFINGER**

Availability

Available

Product type

New

Contract number

Paldrive 371

Dealer E-mail

sales@palfinger.com

Dealer phone

004366488345792

Print date: May 1, 2024, 2:26:34 AM

- Rigid support legs + support leg extension 100mm
- Paltronic 40
- HPSC-E
- Sanreco radio remote control (6L Linearlever)
- Painting RAL3020
- Working lights on the articulated arm
- Hose equipment for two additional devices
- 8 t load hook

### **Platform**

- Platform: length= 6.600mm ,width= 2.480mm in the clear
- Frontwall height 1.800mm inclusive two working lights
- Sidewall height 950mm - Painted RAL9016 on the outside
- Side wall lifting devices + 2 folding steps per side wall
- platform profile 45° + lashing points every 250mm
- Lashing rail in platform
- Platform floor made of 27mm screen printing plates, impregnated and sealed
- Storage box for edge protection profiles
- Set of edge protection profiles (7 pcs.) 800mm length
- two toolboxes installed (plastic)

### **MAN TGS 26.470 6x2-4 LL**

- 470Hp , 2400Nm
- Euro 6e

- 
- TipMatic gearbox 12.26DD + retarder
  - Air suspension on all axles
  - Fuel tank 400l / AD-Blue 60l
  - Tires 1st axle 385/65 R22.5
  - Tires for drive and trailing axles 315/80 R22.5
  - Cabin color: pure white RAL 9016 / chassis color:  
Graphite Black RAL9011
  - Electric and compressed air hanger supply
  - RINGFEDER trailer coupling type 4040 / G150B

**PRODUCT**

<b>Manufacturer</b>	Palfinger	<b>Lifting moment</b>	18,5 mt
<b>Model</b>	PK 19.001 SLD 5	<b>Outreach / Lifting power</b>	12,5m / 1.180Kg
<b>Construction year</b>	2023	<b>Max outreach</b>	12,5 m

**TRUCK**

<b>Truck manufacturer</b>	MAN	<b>Emmission standard</b>	Euro 6e
<b>Vehicle type</b>	Chassis	<b>Axes</b>	6*2*4
<b>Construction year</b>	2023	<b>Gross vehicle weight</b>	26.000 Kg
<b>Drivers cabine</b>	TN	<b>Dead weight</b>	13.700Kg
<b>Wheel base</b>	4.800mm + 1.350mm	<b>Payload</b>	12.300Kg
<b>Power</b>	470 PS	<b>Payload category</b>	6t - 15t
		<b>Construction</b>	Crane and platform



Konstruktionsänderungen vorbehalten, fertigungstechn. Toleranzen müssen berücksichtigt werden.

Krandarstellung symbolisch

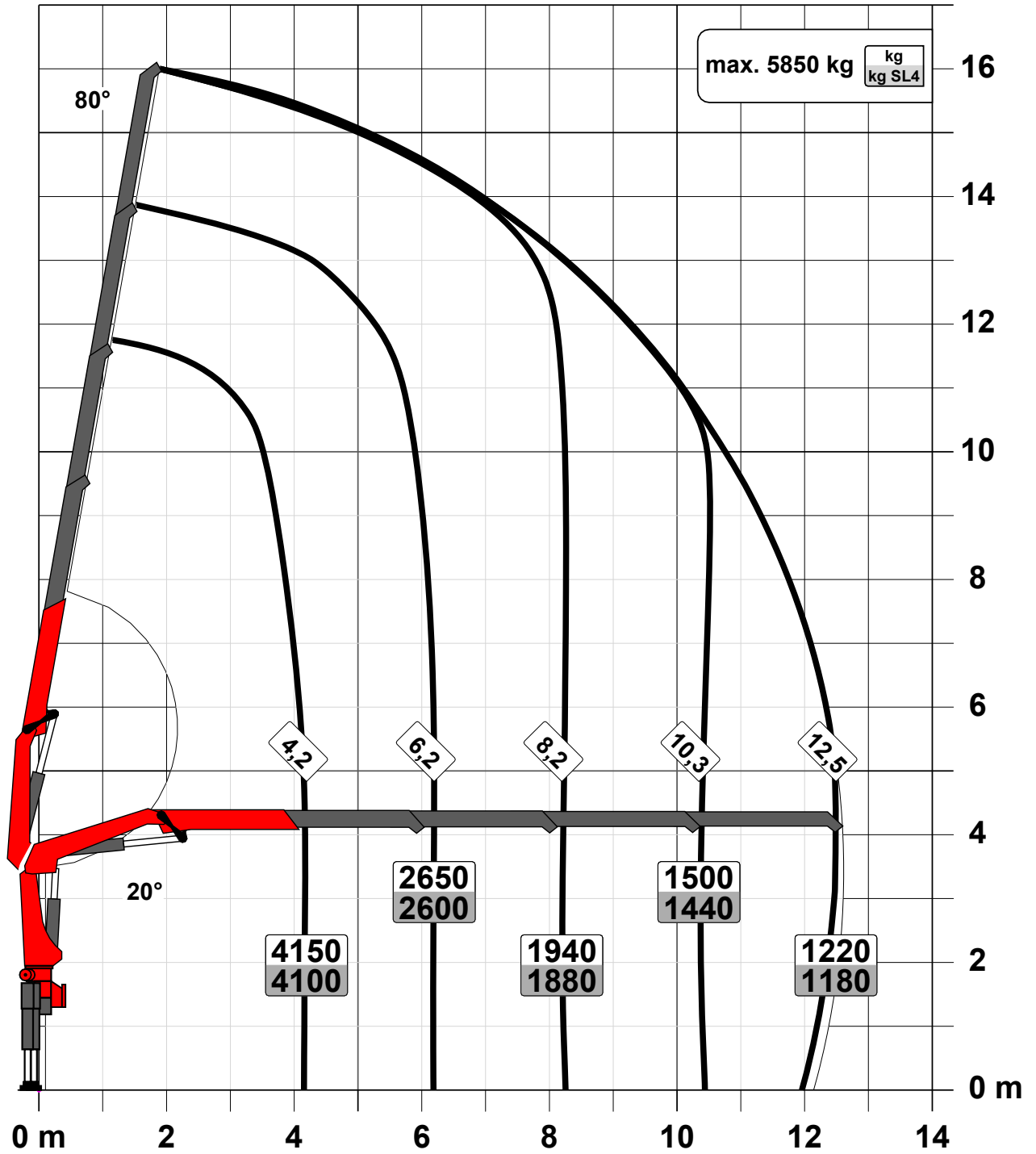

Zulässige Traglasten für Seilwinde siehe Datenblatt  
Seite 020.11000





**PK 17.001 SLD 1 | PK 18.001 SLD 3  
PK 17.001 SLD 3 | PK 19.001 SLD 5**

**SINGLE LINK PLUS  
PERFORMS WELL IN  
CHALLENGING SITUATIONS**

**LIFETIME EXCELLENCE**





# FUNCTIONALITY AND SAFETY REDUCED TO A COMMON DENOMINATOR

- Perfect appearance and extremely high value retention thanks to coating technology
- High degree of user-friendliness thanks to optional radio remote control
- Optimised dead weight
- Additional applications with Single Link Plus







PK 19.001 SLD5 PALFINGER

PK 17.001 SLD 1 (NON-CE)

# PERFECT DIMENSIONS

STD

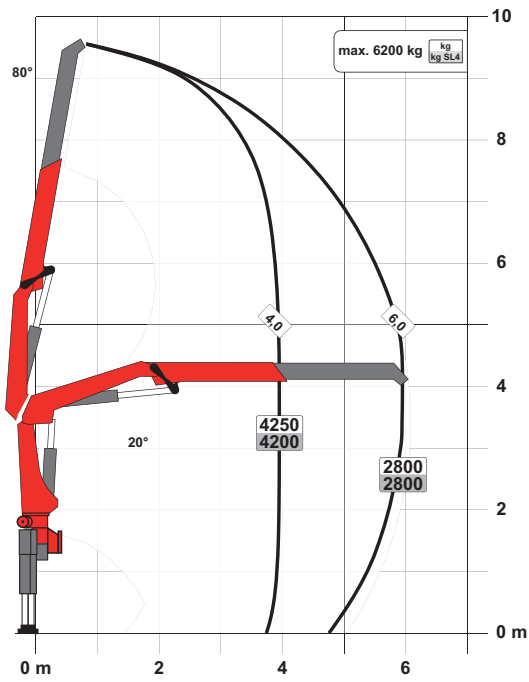

A

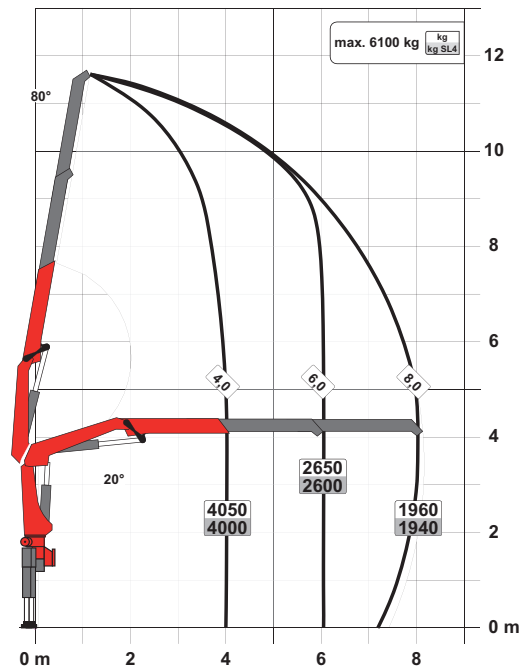

C

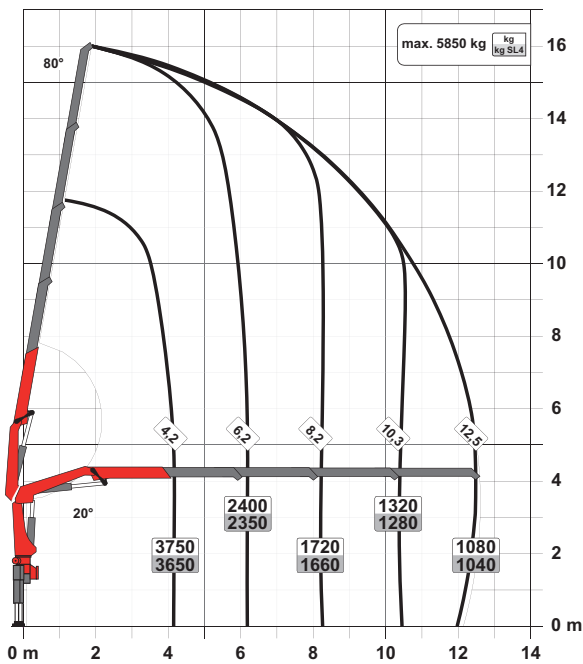

D

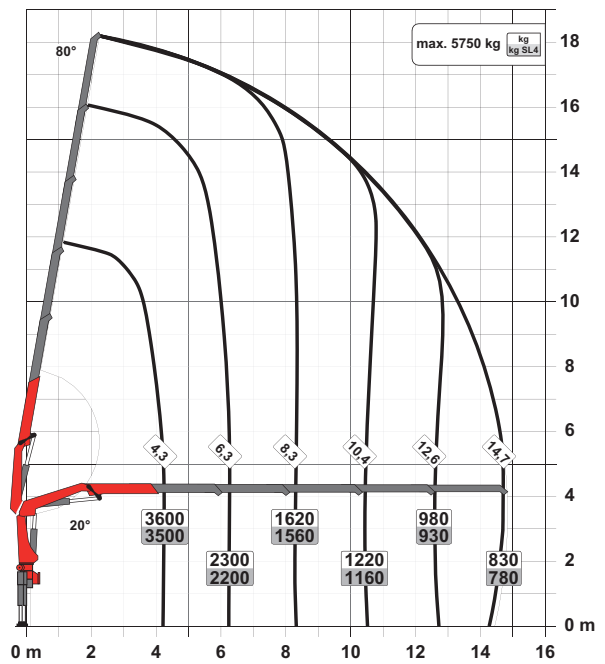

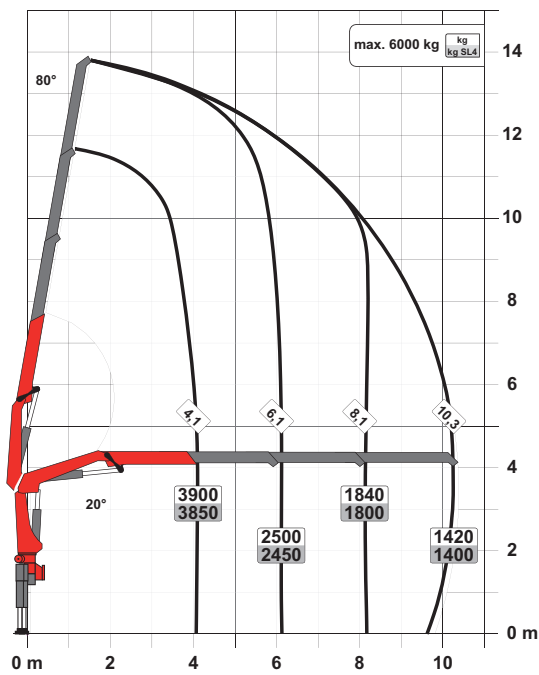
**B**

## SLD 1 (NON-CE)

- Single Link Plus
- Optional:
  - Overload protection OSK
  - Top seat control
  - High stand control
  - Radio remote control
- NON-CE model

## Technical specifications

### EN 12999 HC1 HD4/S2

Max. lifting moment	16.8 mt/164.4 kNm	121250 ft.lb
Max. lifting capacity	6200 kg/60.8 kN	13700 lb
Max. hydraulic outreach	14.8 m	48' 7"
Max. manual outreach	19.0 m	62' 4"
Slewing angle	420°	
Slewing torque	2.0 mt/19.6 kNm	14460 ft.lb
Stabiliser spread (std./max.)	5.0 m/6.6 m	16' 5"/21' 8"
Fitting space required (std.)	0.83 m	2' 8"
Width folded	2.55 m	8' 4"
Max. operating pressure	330 bar	4785 psi
Recommended pump capacity	from 40 l/min to 60 l/min	10.6 US gpm 15.9 US gpm
Dead weight (std.)	1670 kg	3680 lb

# PK 18.001 SLD 3 (NON-CE)

## PERFECT DIMENSIONS

**STD**

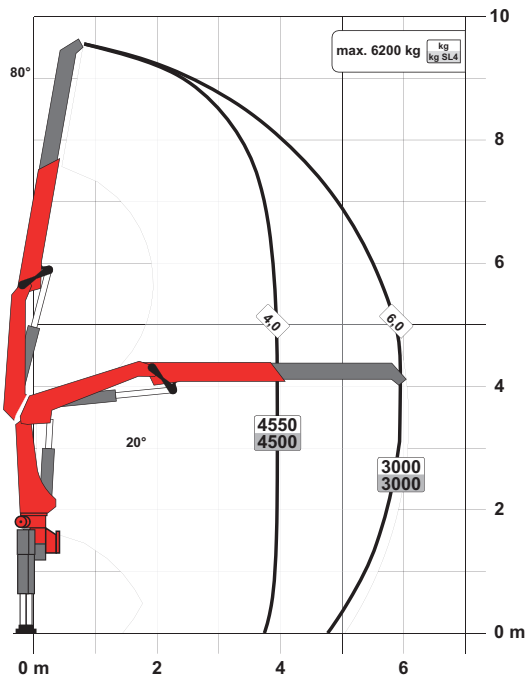

**A**

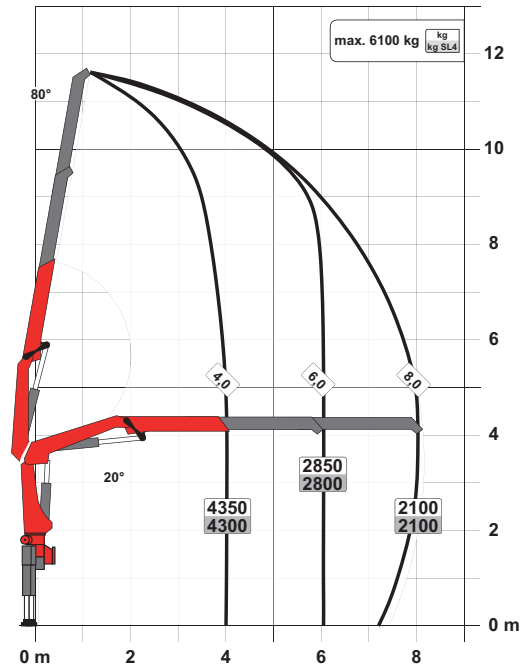

**C**

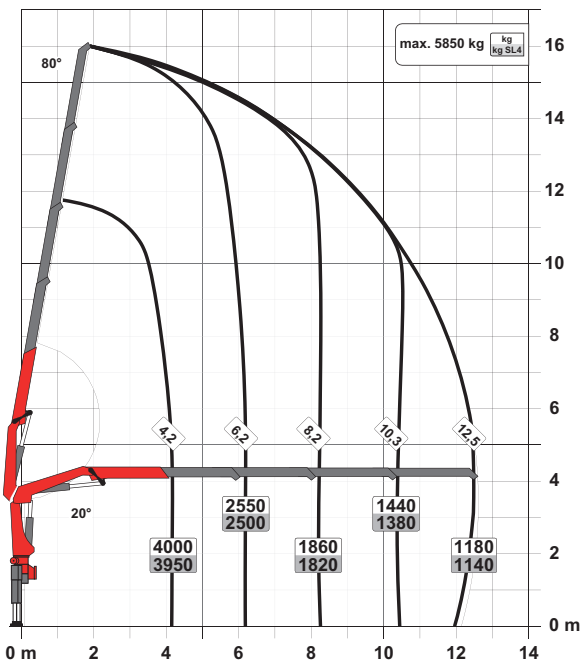

**D**

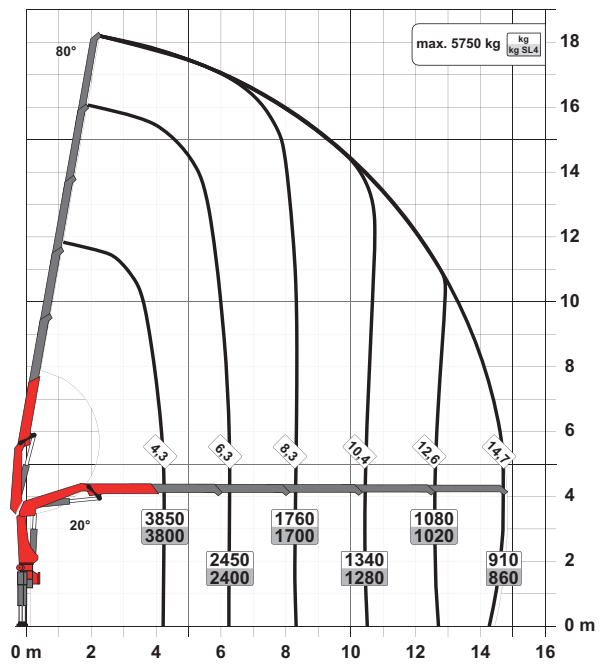

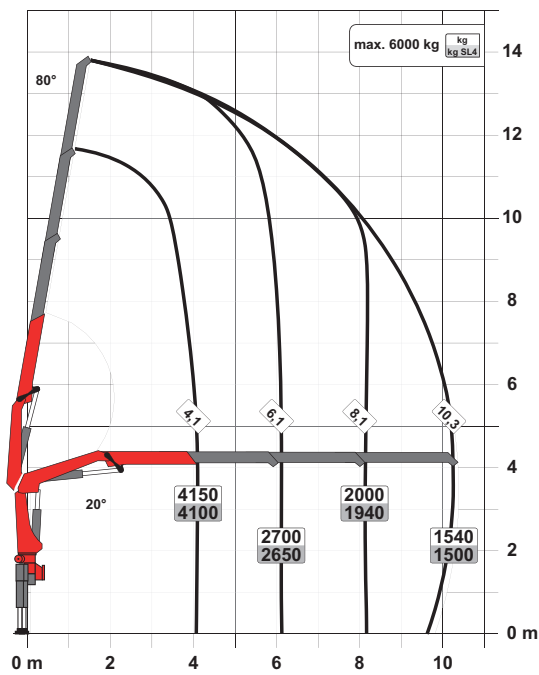

**B**

### SLD 3 (NON-CE)

- Single Link Plus
- M-HPLS
- Paltronic overload protection
- NON-CE model

### Technical specifications EN 12999 HC1 HD4/S2

Max. lifting moment	17.9 mt/175.7 kNm	129580 ft.lb
Max. lifting capacity	6200 kg/60.8 kN	13700 lb
Max. hydraulic outreach	14.8 m	48' 7"
Max. manual outreach	19.0 m	62' 4"
Slewing angle	420°	
Slewing torque	2.0 mt/19.6 kNm	14460 ft.lb
Stabiliser spread (std./max.)	5.0 m/6.6 m	16' 5"/21' 8"
Fitting space required (std.)	0.83 m	2' 8"
Width folded	2.55 m	8' 4"
Max. operating pressure	350 bar	5075 psi
Recommended pump capacity	from 40 l/min to 60 l/min	10.6 US gpm 15.9 US gpm
Dead weight (std.)	1670 kg	3680 lb

# PERFECT DIMENSIONS

## EXTENSION BOOM VARIATIONS

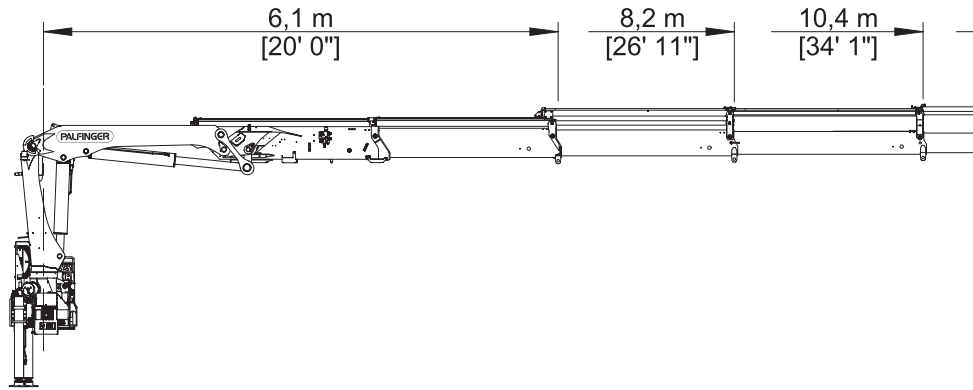
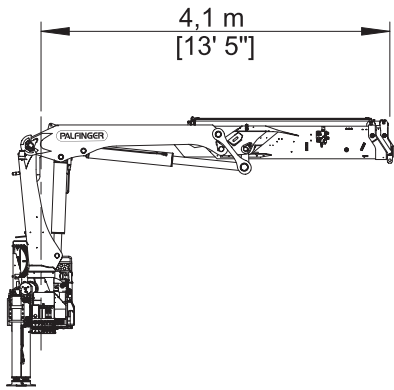

## DIMENSIONS

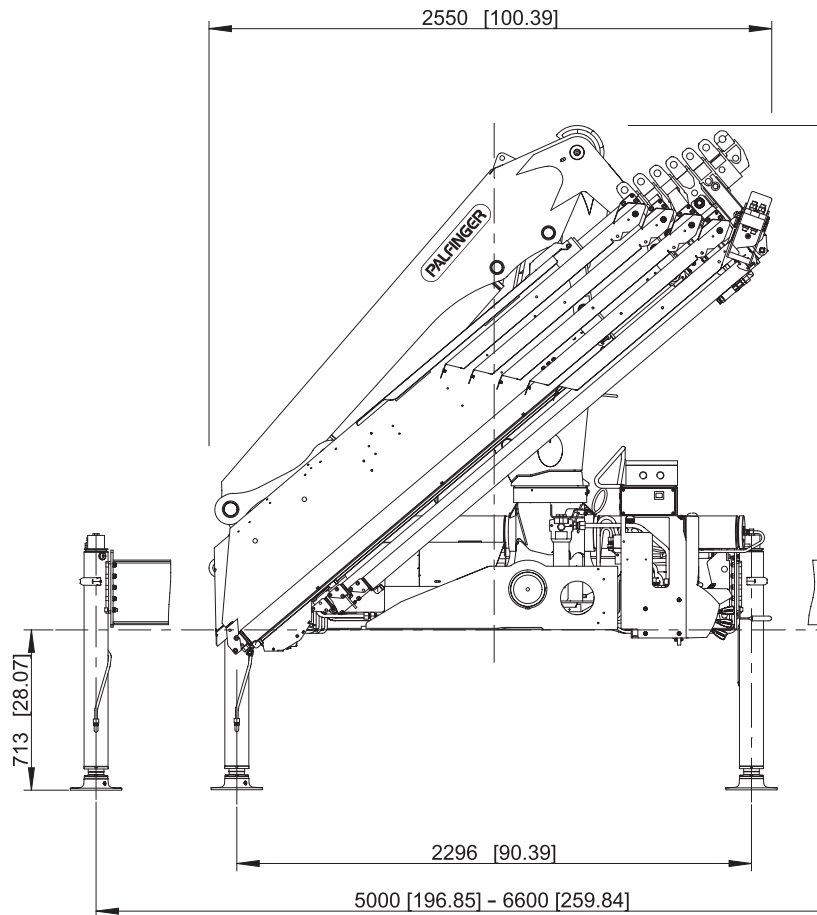
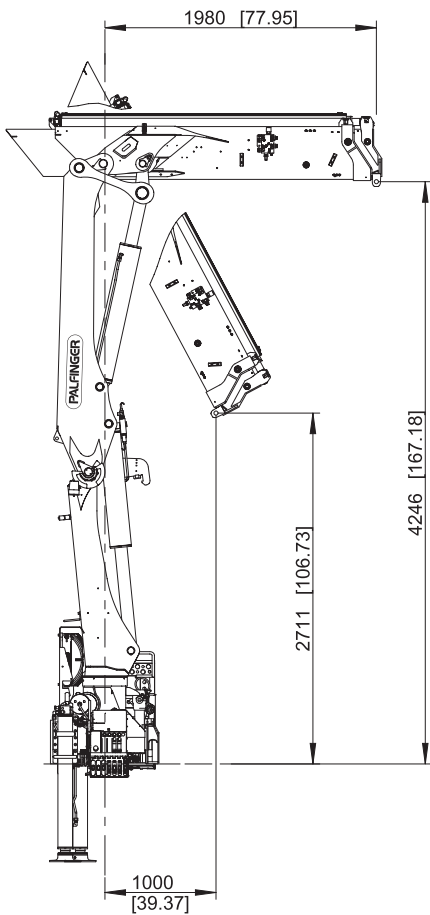

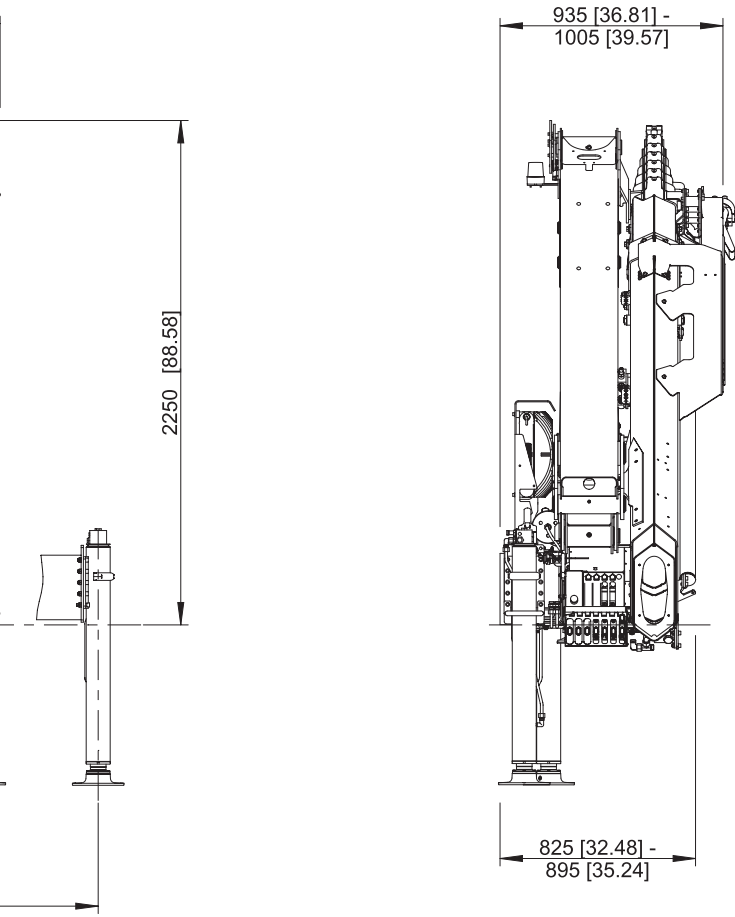
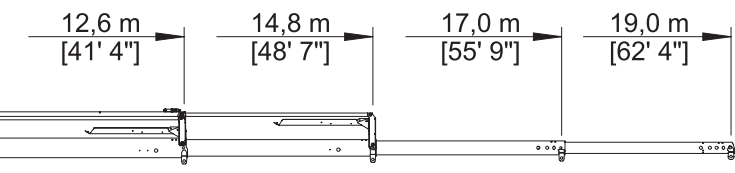

# ABILITY TO WORK EFFICIENTLY AT THE HIGHEST LEVEL

## 9 Highlights



**Single Link Plus**  
Wide-ranging applications

With the 15 degree reverse linkage system, you can reach through low door openings and also work inside buildings. Heavy crane work – even in difficult conditions.



**High Speed Extension**  
For efficient assignments

The High Speed Extension speeds up the extension boom system. Crane works faster and more efficiently.



**Coating technology**  
Top quality surface protection at a glance

The KTL coating lays the foundation for a perfect surface protection. Afterwards the components are either coated in the powder-coating facility or are finished with a two-components-topcoat. High value retention and excellent corrosion protection for the whole life of a crane.

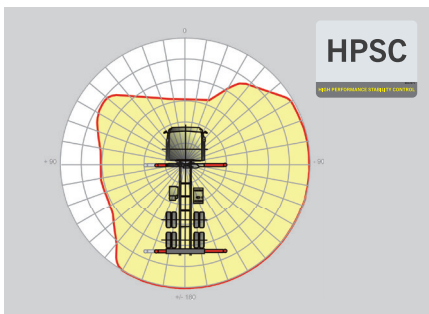

**HPSC\***  
Maximum utilisation of the working range

The variable stabiliser positioning of the High Performance Stability Control System allows the full lifting capacity of the crane to be used, even when working within tight spaces.

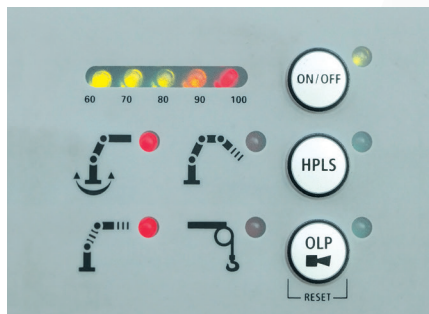

**Paltronic\***  
Comfort and safety

The paltronic, PALFINGER offers the latest control electronics for the series production crane. The custom designed electronic operates and monitors the crane and offers more efficiency in use and safety.



**Radio remote control\***  
Dialogue with the operator

PALFINGER radio remote controls are equipped with linear lever or cross lever and provide the greatest possible comfort for the operator. All SLD 5 models with LED-Display inform the crane operator about the different operating conditions.





**Hose equipment for attachments\***  
Enhances versatility

The hose equipment offers an easy means of connecting auxiliary equipment. The hose equipment is guided in hose trays for protection.



**Lighting package\***  
More crane safety particularly at dusk and dark

LEDs which backlight the control panel make it easier to read off the crane functions and provide the crane operator with a quick overview of the entire panel during the working process. LED warning lights in the supporting cylinders mean greater safety for crane operator and passers-by.



**Control console**  
All information at a glance

All important information about the crane can be seen on the main control stand. A digital indicator counts and displays the operating hours. Ergonomic control levers and the optional lighting package provide increased safety and comfort even in poor visibility conditions.



PK 17.001 SLD 3

# PERFECT DIMENSIONS

STD

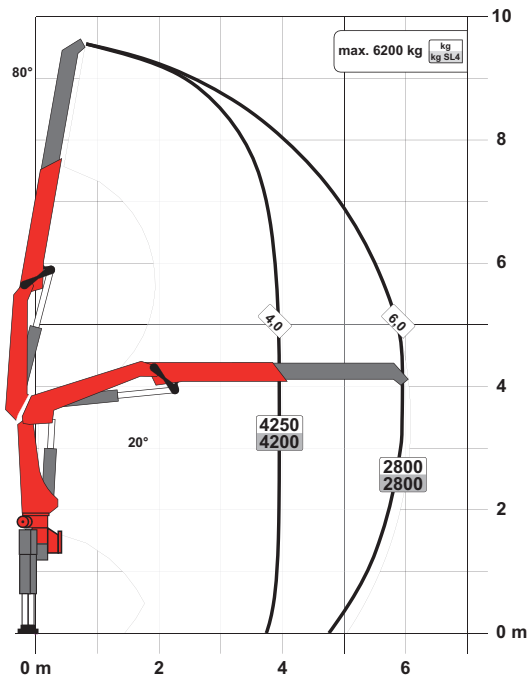

A

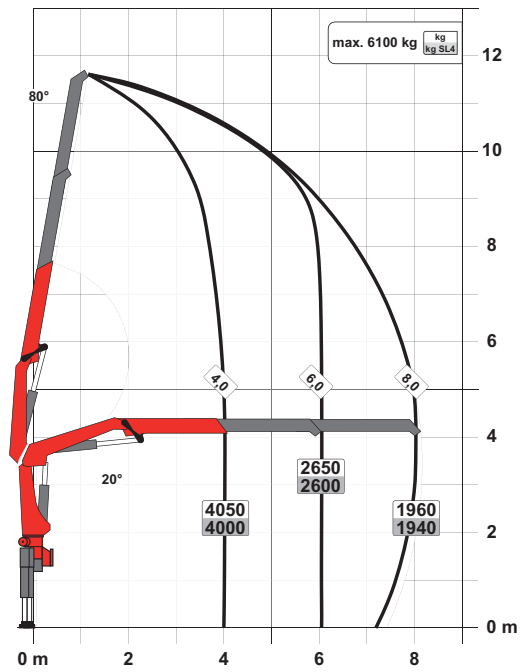

C

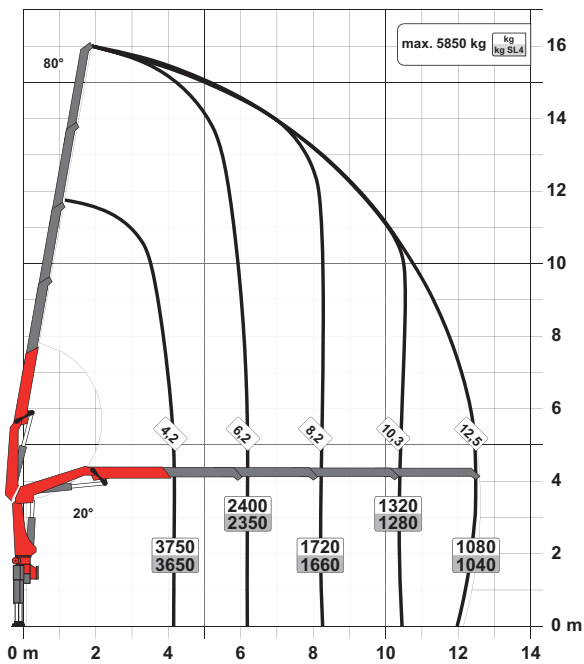

D

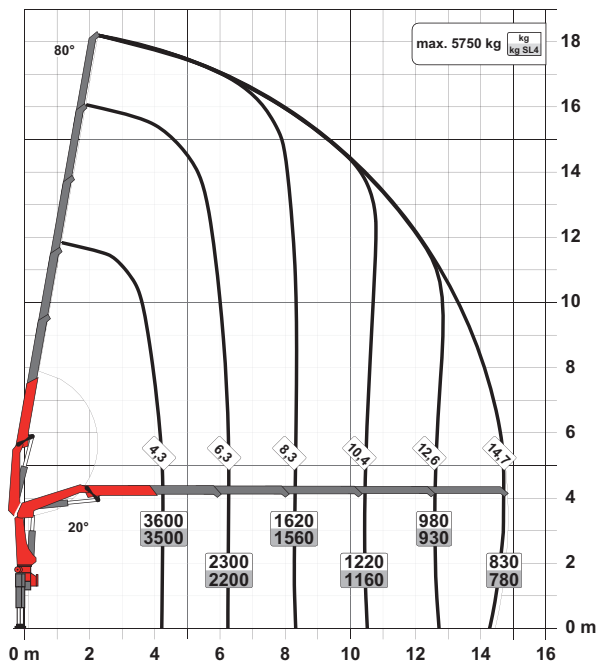

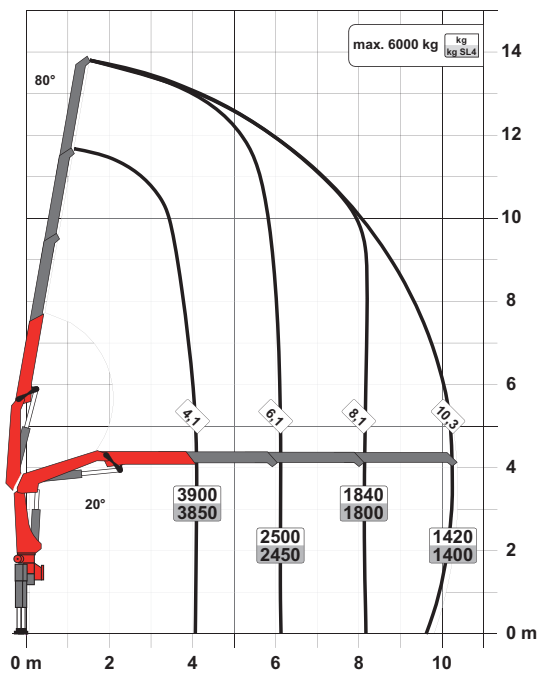
**B**

### SLD 3

- Single Link Plus
- Paltronic overload protection
- Optional:
  - Stability monitoring system ISC-S (standard for CE), HPSC-L, HPSC-E
  - High stand control
  - Radio remote control
  - Rope winch 2.5t on the knuckle boom
- NON-CE and CE model

### Technical specifications

EN 12999 HC1 HD4/S2

Max. lifting moment	16.8 mt/164.4 kNm	121250 ft.lb
Max. lifting capacity	6200 kg/60.8 kN	13700 lb
Max. hydraulic outreach	14.8 m	48' 7"
Max. manual outreach	19.0 m	62' 4"
Slewing angle	420°	
Slewing torque	2.0 mt/19.6 kNm	14460 ft.lb
Stabiliser spread (std./max.)	5.0 m/6.6 m	16' 5"/21' 8"
Fitting space required (std.)	0.83 m	2' 8"
Width folded	2.55 m	8' 4"
Max. operating pressure	330 bar	4785 psi
Recommended pump capacity	from 40 l/min to 60 l/min	10.6 US gpm 15.9 US gpm
Dead weight (std.)	1670 kg	3680 lb

PK 19.001 SLD 5

# PERFECT DIMENSIONS

STD

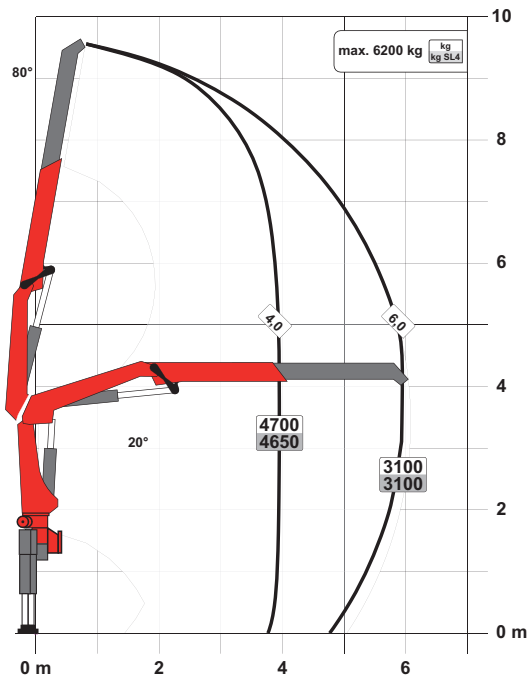

A

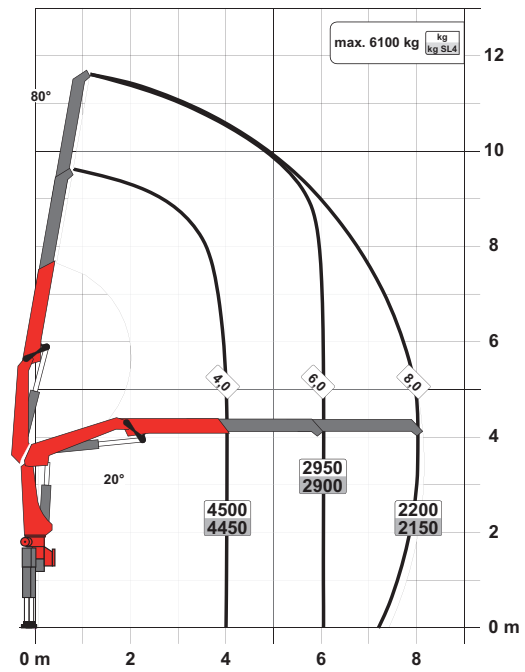

C

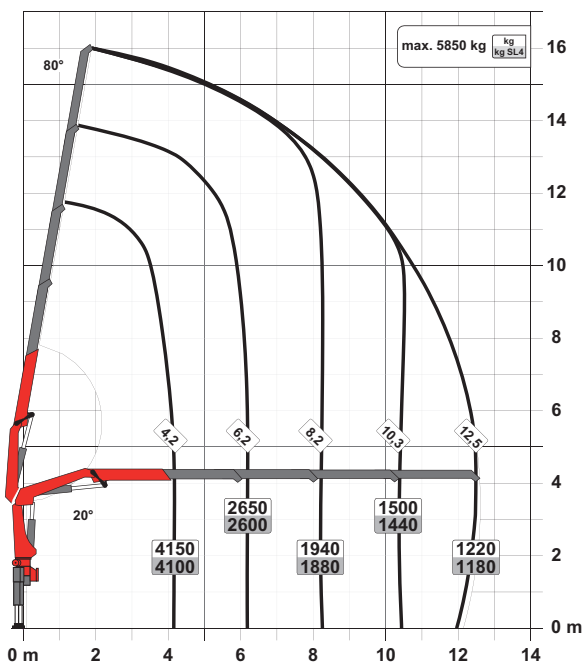

D

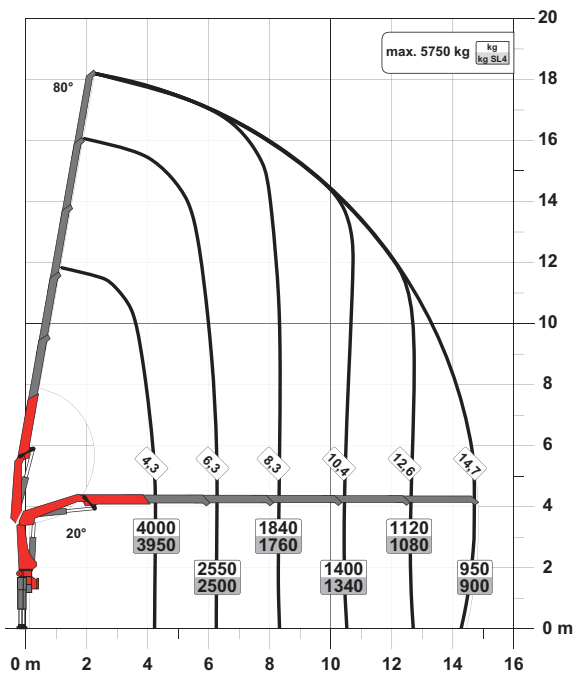

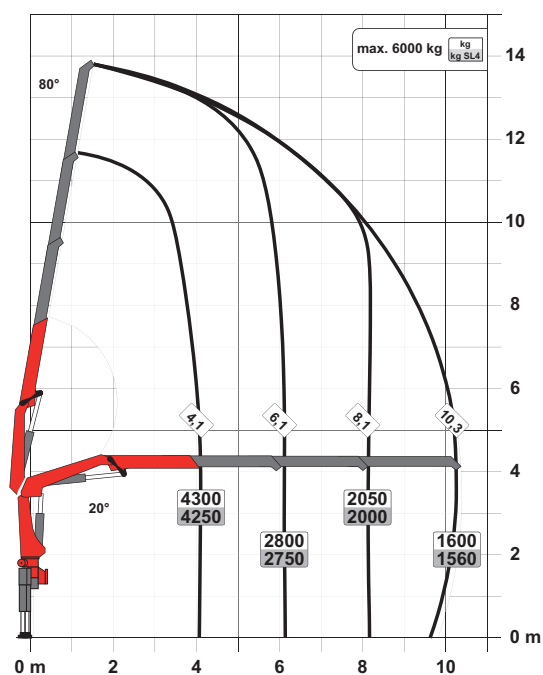

**B**

## SLD 5

- Single Link Plus
- Paltronic overload protection
- E-HPLS
- Load Sensing valve
- Radio remote control with LED display
- Optional:
  - Stability monitoring system ISC-S (standard for CE), HPSC-L, HPSC-E
  - Rope winch 2.5t on the knuckle boom
- NON-CE and CE model

## Technical specifications

### EN 12999 HC1 HD4/S2

Max. lifting moment	18.5 mt/181.4 kNm	133780 ft.lb
Max. lifting capacity	6200 kg/60.8 kN	13700 lb
Max. hydraulic outreach	14.8 m	48' 7"
Max. manual outreach	19.0 m	62' 4"
Slewing angle	420°	
Slewing torque	2.0 mt/19.6 kNm	14460 ft.lb
Stabiliser spread (std./max.)	5.0 m/6.6 m	16' 5"/21' 8"
Fitting space required (std.)	0.83 m	2' 8"
Width folded	2.55 m	8' 4"
Max. operating pressure	360 bar	5220 psi
Recommended pump capacity	from 60 l/min to 80 l/min	15.9 US gpm to 21.1 US gpm
Dead weight (std.)	1700 kg	3750 lb



KP-PK17/19SLDM4+EN

Cranes shown in the leaflet are partially optional equipped and do not always correspond to the standard version. Country-specific regulations must be observed. Dimensions may vary. Subject to technical changes, errors and translation mistakes.