

TUNLIFT
IVECO DAILY 70C18

NEU

VERFÜGBAR



INFORMATIONEN ZUM ANGEBOT

Montage- & Besichtigungsstandort

Modena, 41122 - Italien 

Verkaufsabwicklung und Auslieferung durch Händler:

Palfinger SRL

Verfügbarkeit

Verfügbar

Produktzustand

Neu

Kontaktperson

Palfinger SRL

E-Mail

info@palfingerplatformsitaly.it

Telefonnummer

059252426

PRODUKT

| | | | |
|-------------------|-----------|---------------------|--------|
| Hersteller | PALFINGER | Arbeitshöhe | 7,00 m |
| Gerätetyp | TUNLIFT | Korblast | 500 kg |
| Baujahr | 2022 | Korbmaterial | ALU |

FAHRZEUG

| | | | |
|-----------------------|-------|---------------------------------|---------|
| LKW Hersteller | IVECO | Schadstoffklasse | EURO 6 |
| Radstand | 3700 | Achsen | 4x2 |
| | | Zulässiges Gesamtgewicht | 7,5 TON |

PALFINGER

TUNLIFT 7.37-500

**IDEALE PER INTERVENTI
STRADALI DINAMICI, LA
MANUTENZIONE DI GALLERIE
E SOTTOPASSAGGI.**

LIFETIME EXCELLENCE



PUNTI DI FORZA

- Piattaforma concepita per le esigenze dei lavori stradali; ad esempio, interventi in gallerie, sottopassaggi, ponti, autostrade, strade.
- Attacchi per corrente elettrica, acqua, aria compressa predisposti in piattaforma.
- Movimentazione dell'autocarro da cesto come semovente.
- Cesta basculante ed estensibile
- Possibilità di ispezionare tutta la volta della galleria senza limitare il traffico sulla corsia di marcia opposta.

STANDARD





- Agganci cinture di sicurezza
- Avviamento e spegnimento autocarro dalla consolle di comando
- Cartello "cantiere Mobile" applicato sul retro della macchina dotato di 4 luci lampeggianti arancioni
- Consolle di comando
- Controllo macchina chiusa
- Lampade alta intensità orientabili installate in piattaforma al fine di illuminare i punti di intervento
- Limitatore di carico
- Piattaforma tunnel inspection con cesto estensibile e basculante per adattarsi alla volta del tunnel.
- Rotolampade di colore giallo sulla cabina del veicolo
- Ruote motorizzate idraulicamente e sterzanti, attivabili dalla piattaforma in modalità semovente
- Scala di accesso alla piattaforma illuminate all'attivazione della macchina

ACCESSORI PRINCIPALI

- Compressore d'aria professionale 10 bar attivabile dalla piattaforma
- Generatore di corrente 230 v - 5 kw attivabile dalla piattaforma
- Motore elettrico di funzionamento della sola macchina 230 v/2.2kw
- Idrogetto alta pressione 200 bar con accumulo di acqua a bordo



DATI TECNICI

| | | |
|--|---------------------------|-----------------------|
|  | Max. altezza di lavoro | 7 m |
|  | Sbalzo operativo laterale | M 1,0 dx + 1,0 m sx |
|  | Portata massima | 500 Kg |
|  | Comandi | Elettro-idraulici |
|  | Stabilizzazione | N 4 a discesa diretta |

DIAGRAMMI DI LAVORO

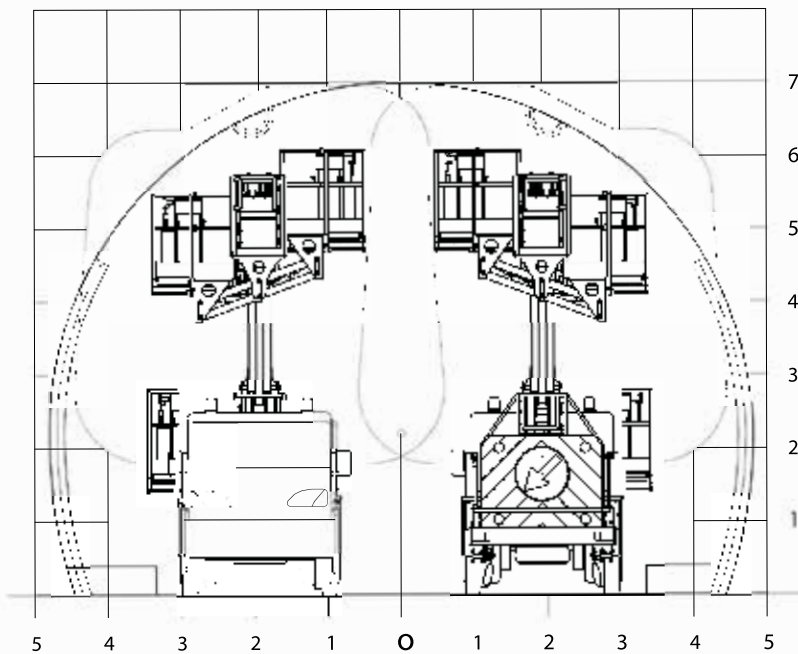

Masse suscettibili ad una variazione +/- 5%
Dati tecnici suscettibili ad una variazione +/- 3%
*230 kg con il cestello in VTR

DIMENSIONI



CONTATTO**PALFINGER PLATFORMS ITALY SRL**

Via Enrico De Nicola, 31
41122 Modena (MO) - Italy
TEL: +39 059 252426
EMAIL: info@palfingerplatformsitaly.it

Le unità mostrate nell'opuscolo possono essere equipaggiate con accessori opzionali e non sempre corrispondono alla versione di serie. Nella costruzione è necessario rispettare le normative nazionali. Le dimensioni indicate non sono vincolanti. Con riserva di modifiche tecniche, errori ed errori di traduzione.

PALFINGER

P 160 A LOW SMART
AGILE AND COMPACT, WITH
STABILISATION WITHIN
VEHICLE LIMITS, PERFECT
FOR TOWN CENTRES

LIFETIME EXCELLENCE

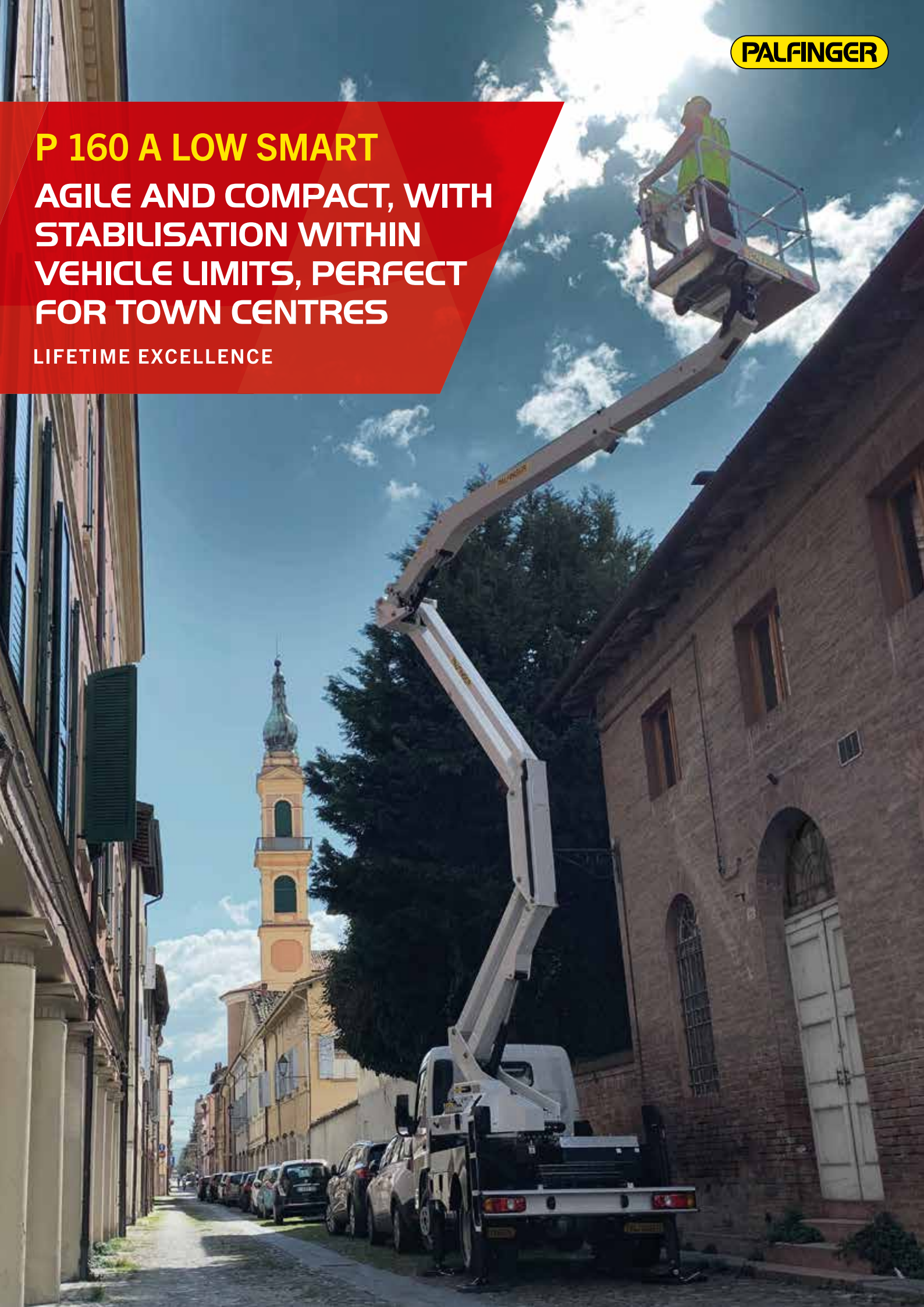

STRENGTHS

- Basket rotation 90° left and 90° right as standard for greater agility
- Ultra-compact installation on short-wheelbase vehicles and stabilisation within truck's outer limits enable agile operation in even the most inaccessible urban contexts
- Long stabiliser stroke for optimal compensation of uneven ground

STANDARD











- 12 V socket on basket
- 230 V or 110 V / 16 A socket on basket
- 90°+90° basket rotation
- Basket air/water line
- Electric hour meter
- Emergency hand pump
- Emergency stop buttons
- Engine start and stop from basket
- Flanged lock valves on all cylinders
- Levelling control device
- Magnetic flashing beacon for vehicle cab
- Panel light test button
- Relief valves on hydraulic system
- Stabiliser/boom interlock
- Two-sided basket access

MAIN ACCESSORIES

- 230 V / 16 A or 110 V / 16 A electric pump
- 60 W working beacon on basket
- Custom painting of aerial platform
- Custom painting of truck cab
- Fibreglass basket as alternative to standard
- Fibreglass basket with 1000 V insulation as alternative to standard
- Flashing beacon on turntable
- Folding left and right side bordering h 200 m
- Inclinator with acoustic alarm
- Set of brushes to protect telescopic boom
- Weight distributor plates 400x400x40 mm



TECHNICAL DATA

| | | | | | |
|--|--|-----------|---|----------------------|-----------------------------------|
|  | Max. working height | 16,0 m |  | Basket rotation | 2x90° |
|  | Max. working height from platform deck | 14,0 m |  | Basket dimensions | m 1,4 x 0,84 x 1,1 h |
|  | Max. working outreach | 6,3 m |  | Basket capacity | 200 kg |
|  | Min. stabiliser width | 1,85 m |  | Stabilisation | Vertical within limits of vehicle |
|  | Main boom working angle | -30°/+60° |  | Gross vehicle weight | 3,5 t |
|  | Turntable rotation | 260° | | | |

WORK AREA

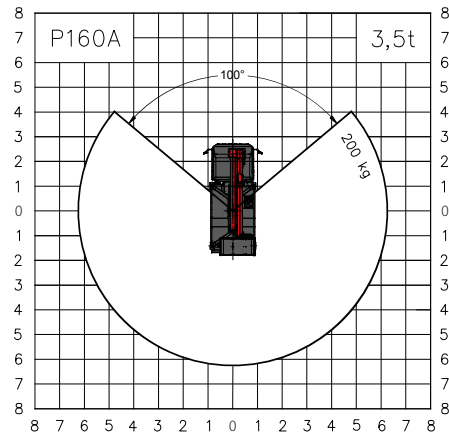
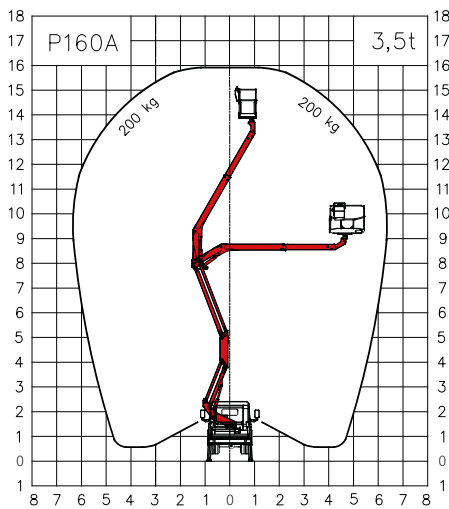

Weights subject to +/-5% variation
 Technical data subject to +/-3% variation

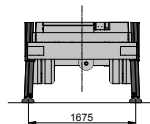

DIMENSIONS



CONTACT DETAILS**PALFINGER PLATFORMS ITALY SRL**

Via Enrico De Nicola, 31
41122 Modena (MO) - Italy
TEL: +39 059 252426
EMAIL: info@palfingerplatformsitaly.it

KP-P160AM3+EN

Units shown in the brochure may be equipped with optional accessories and are not always standard versions.
National regulations must be complied with during construction.
The dimensions shown are not binding.
Subject to technical changes, errors and translation inaccuracies.