

**P 160 A**  
**MITSUBISHI FUSO**

NEU

VERFÜGBAR

AUF LAGER

SYMBOLFOTO



**INFORMATIONEN ZUM ANGEBOT**

Montage- & Besichtigungsstandort

Modena, 41122 - Italien 

Verkaufsabwicklung und Auslieferung durch Händler:

Palfinger SRL

Verfügbarkeit

**Verfügbar**

Produktzustand

Neu

Kontaktperson

Palfinger SRL

E-Mail

[info@palfingerplatformsitaly.it](mailto:info@palfingerplatformsitaly.it)

Telefonnummer

**059252426**

**PRODUKT**

<b>Hersteller</b>	PALFINGER	<b>Drehbereich</b>	360°
<b>Baujahr</b>	2021	<b>Korbgröße</b>	1,4 x 0,7 x 1,1 m
<b>Reichweite</b>	6,30 m	<b>Korblast</b>	200 kg
<b>Arbeitshöhe</b>	16,00 m	<b>Korbmaterial</b>	ALU

**FAHRZEUG**

<b>LKW Hersteller</b>	MITSUBISHI	<b>Schadstoffklasse</b>	EURO 6
<b>Fahrerhaus</b>	B	<b>Achsen</b>	4x2
<b>Radstand</b>	2500	<b>Zulässiges Gesamtgewicht</b>	3,5 TON

**PALFINGER**

**P 160 A LOW SMART**  
**AGILE AND COMPACT, WITH**  
**STABILISATION WITHIN**  
**VEHICLE LIMITS, PERFECT**  
**FOR TOWN CENTRES**

LIFETIME EXCELLENCE





## STRENGTHS

- Basket rotation 90° left and 90° right as standard for greater agility
- Ultra-compact installation on short-wheelbase vehicles and stabilisation within truck's outer limits enable agile operation in even the most inaccessible urban contexts
- Long stabiliser stroke for optimal compensation of uneven ground

## STANDARD











- 12 V socket on basket
- 230 V or 110 V / 16 A socket on basket
- 90°+90° basket rotation
- Basket air/water line
- Electric hour meter
- Emergency hand pump
- Emergency stop buttons
- Engine start and stop from basket
- Flanged lock valves on all cylinders
- Levelling control device
- Magnetic flashing beacon for vehicle cab
- Panel light test button
- Relief valves on hydraulic system
- Stabiliser/boom interlock
- Two-sided basket access

## MAIN ACCESSORIES

- 230 V / 16 A or 110 V / 16 A electric pump
- 60 W working beacon on basket
- Custom painting of aerial platform
- Custom painting of truck cab
- Fibreglass basket as alternative to standard
- Fibreglass basket with 1000 V insulation as alternative to standard
- Flashing beacon on turntable
- Folding left and right side bordering h 200 m
- Inclinomometer with acoustic alarm
- Set of brushes to protect telescopic boom
- Weight distributor plates 400x400x40 mm



## TECHNICAL DATA

	Max. working height	16,0 m		Basket rotation	2x90°
	Max. working height from platform deck	14,0 m		Basket dimensions	m 1,4 x 0,84 x 1,1 h
	Max. working outreach	6,3 m		Basket capacity	200 kg
	Min. stabiliser width	1,85 m		Stabilisation	Vertical within limits of vehicle
	Main boom working angle	-30°/+60°		Gross vehicle weight	3,5 t
	Turntable rotation	260°			

## WORK AREA

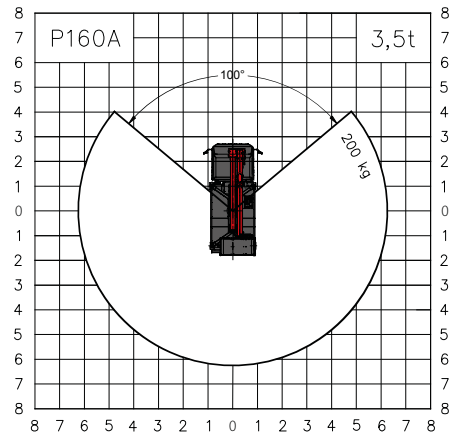
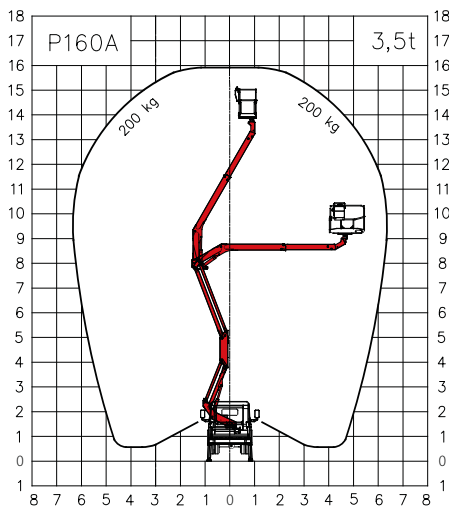

Weights subject to +/-5% variation  
 Technical data subject to +/-3% variation

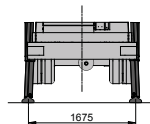

## DIMENSIONS



**CONTACT DETAILS****PALFINGER PLATFORMS ITALY SRL**

Via Enrico De Nicola, 31  
41122 Modena (MO) - Italy  
TEL: +39 059 252426  
EMAIL: [info@palfingerplatformsitaly.it](mailto:info@palfingerplatformsitaly.it)

**KP-P160AM3+EN**

Units shown in the brochure may be equipped with optional accessories and are not always standard versions.  
National regulations must be complied with during construction.  
The dimensions shown are not binding.  
Subject to technical changes, errors and translation inaccuracies.

# PLATFORMS | AREA SALES MANAGER



**HEAD OF SALES**  
MICHAEL GRUBÖCK



**LAURA GARAGNANI**  
**Responsible Areas:**  
France, Portugal, Spain, Ireland United Kingdom



**CHRISTIAN BUSCH**  
**Responsible Areas:**  
Switzerland, Slovakia, Hungary, Romania, Bulgaria, Australia, New Zealand, Georgia



**TIMO LENZEN**  
**Responsible Areas:**  
Norway, Sweden, Finland, Island, Denmark, Faroe Islands, Latvia, Lithuania, Estonia, Czech Republic, Poland, Ukraine, Moldova



**ADNAN ISSA**  
**Responsible Areas:**  
Netherlands, Belgium, Luxembourg



**NICOLAS HARTER**  
**Responsible Areas:**  
Slovenia, Croatia, Greece, Cyprus, Serbia, Bosnia, Kosovo, Montenegro, Albania, Macedonia, Israel, Turkey, Georgia, Syria, Lebanon, Jordan, Iraq, Iran, Afghanistan, Saudi Arabia, Kuwait, Bahrain, Qatar, UAE, Oman, Yemen



**NANCY NYAMBURA**  
**Responsible Areas:**  
Africa



**JOHANN POSCHNER**  
**Responsible Areas:**  
Germany, Austria



**ALFREDO CAREDDU**  
**Responsible Areas:**  
Italy, Malta

