

# P 200 A-R SMART

**COMPACT DESIGN  
AND QUICK  
AND EASY TO USE**

**LIFETIME EXCELLENCE**



## STRENGTHS

- Lightweight and compact double articulated aerial platform for work in tight spaces, mounted on a 3.5 t truck. The double pantograph unit guarantees great versatility and the ability to move over in elevated positions.
- User-friendly hydraulic controls
- Single stabilisation system for quick positioning
- All metal structural work features cathodic electrodeposition coating, with KTL system patented by PALFINGER.

## STANDARD

- 230V / 16A socket A or 110V / 16A 12V socket on basket
- Aerial section centring display for aerial part closing
- Air/water line from the column to the basket
- Electric hour meter
- Top boom protection
- Cage rotation 90°+ 90°
- Mechanical anti-collision system cab/boom
- Painting with cathaphoresis process, with KTL system patented by PALFINGER
- Spreader plates with proper housing on the chassis 12V socket on basket.











## MAIN ACCESSORIES

- 12V electric pump for emergency lowering
- 230V / 16A or 110V / 16A electric pump with quick coupler
- Brushes kit on telescopic boom
- Fiberglass basket (replacement for aluminium cage)
- 1000V insulation on fibreglass basket
- Flashing light at turntable
- Folding left and right side bordering h = 200mm
- Inclinator with audio alarm signal and signal lights relating to aerial work conditions
- Plastic storage toolbox at the rear
- Side protection.





## TECHNICAL DATA

|  |  |           |   |                               |  |
|--|--|-----------|---|-------------------------------|--|
|  | Max. working height                    | 19.6 m    |  | Basket rotation               | 2x90°                                    |
|  | Max. working height from platform deck | 17.6 m    |  | Basket dimensions             | m 1.4 x 0.84 x 1.1 h                     |
|  | Max. working outreach                  | 8.2 m     |  | Max. load permitted on basket | 230 kg                                   |
|  | Outrigger width                        | 2.5 m     |  | Stabilization                 | 4, "A"-shaped, direct descent outriggers |
|  | Operating angle of main arm            | -25°/+73° |  | Gross vehicle weight          | 3.5 t                                    |
|  | Turret rotation                        | 380°      |   |                               |  |

## WORK AREA

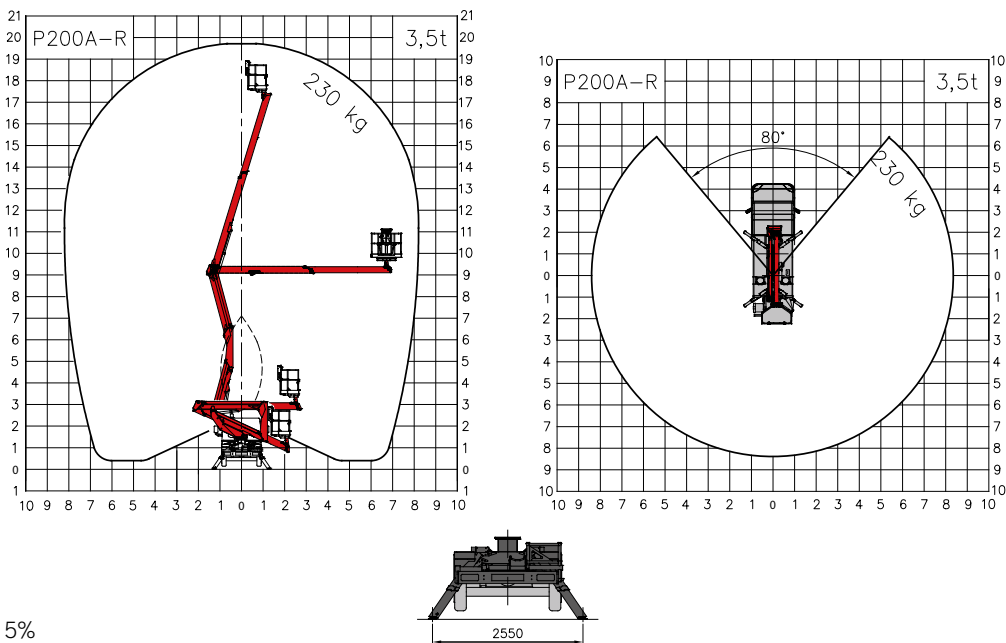

## DIMENSIONS



**CONTACT DETAILS**

**PALFINGER PLATFORMS ITALY SRL**  
Via Enrico De Nicola, 31  
41122 Modena (MO) - Italy  
TEL: +39 059 252426  
EMAIL: [info@palfingerplatformsitaly.it](mailto:info@palfingerplatformsitaly.it)

**KP-P200ARM1+EN**

The illustrations in the brochure may show units equipped with optional accessories and not always the standard version. National legislation must be complied with during construction/assembly. The dimensions stated are not binding. The company cannot be held responsible for any changes in technical information, inaccuracies, or translation errors.